

A

a

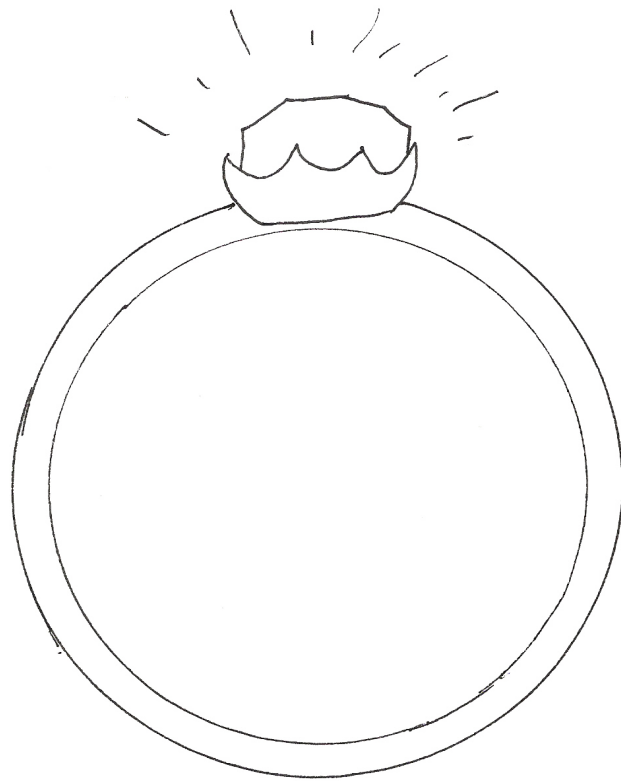

anillo

B

b

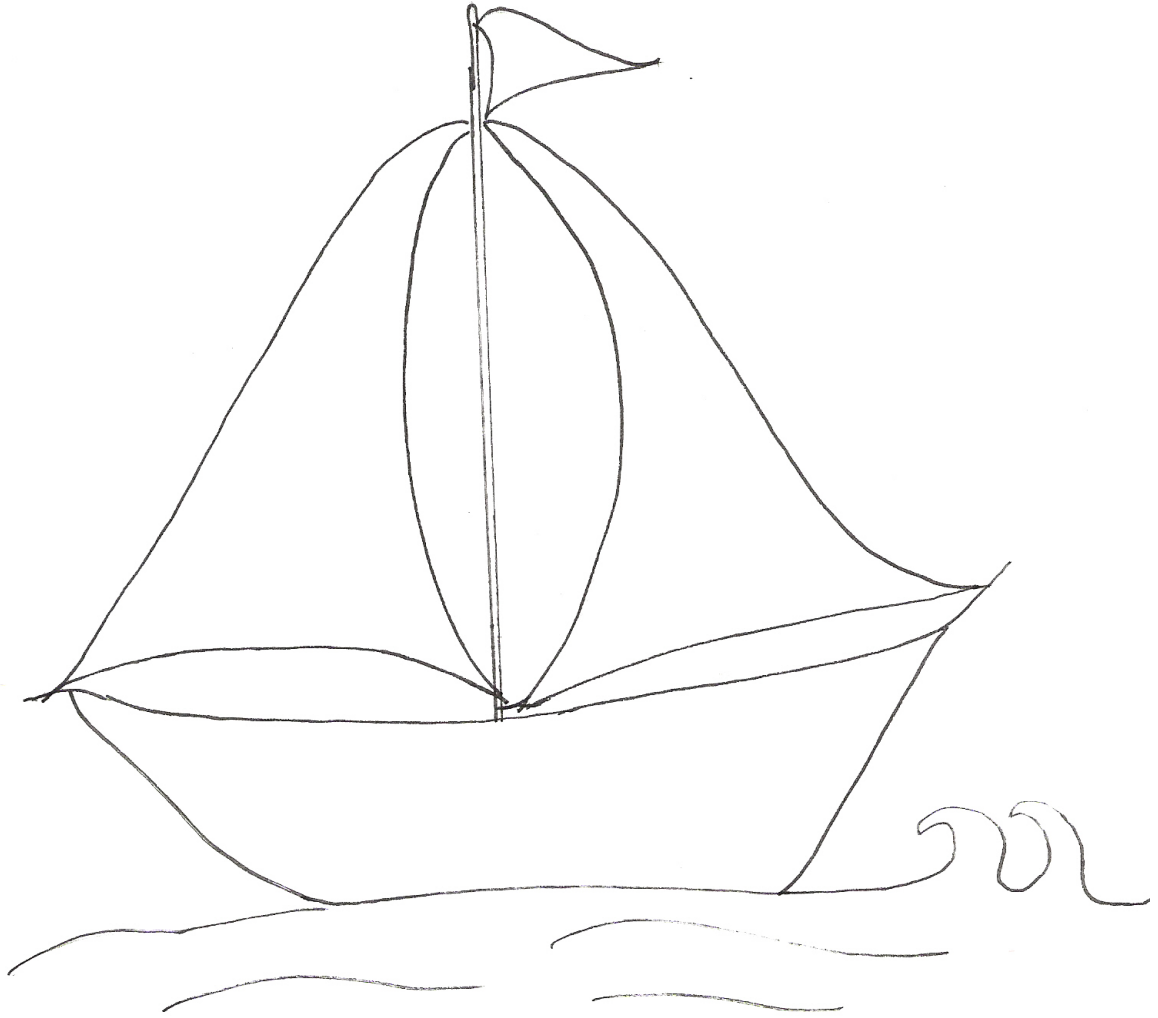

barco

B

b

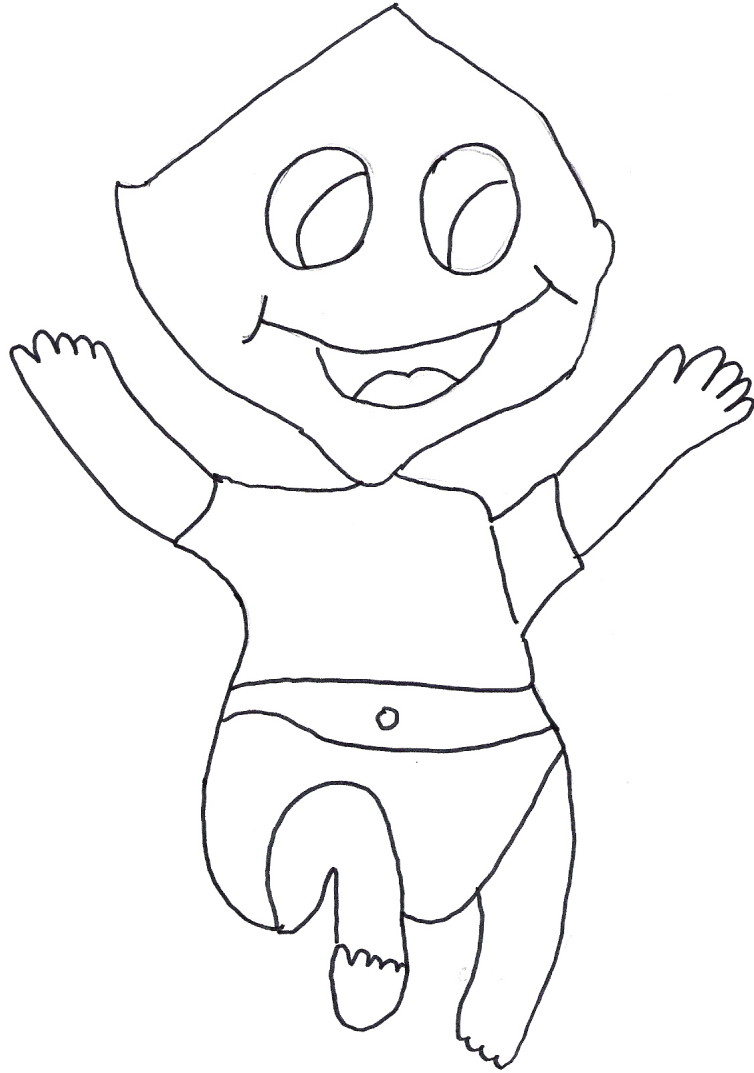

b e b e

B

b

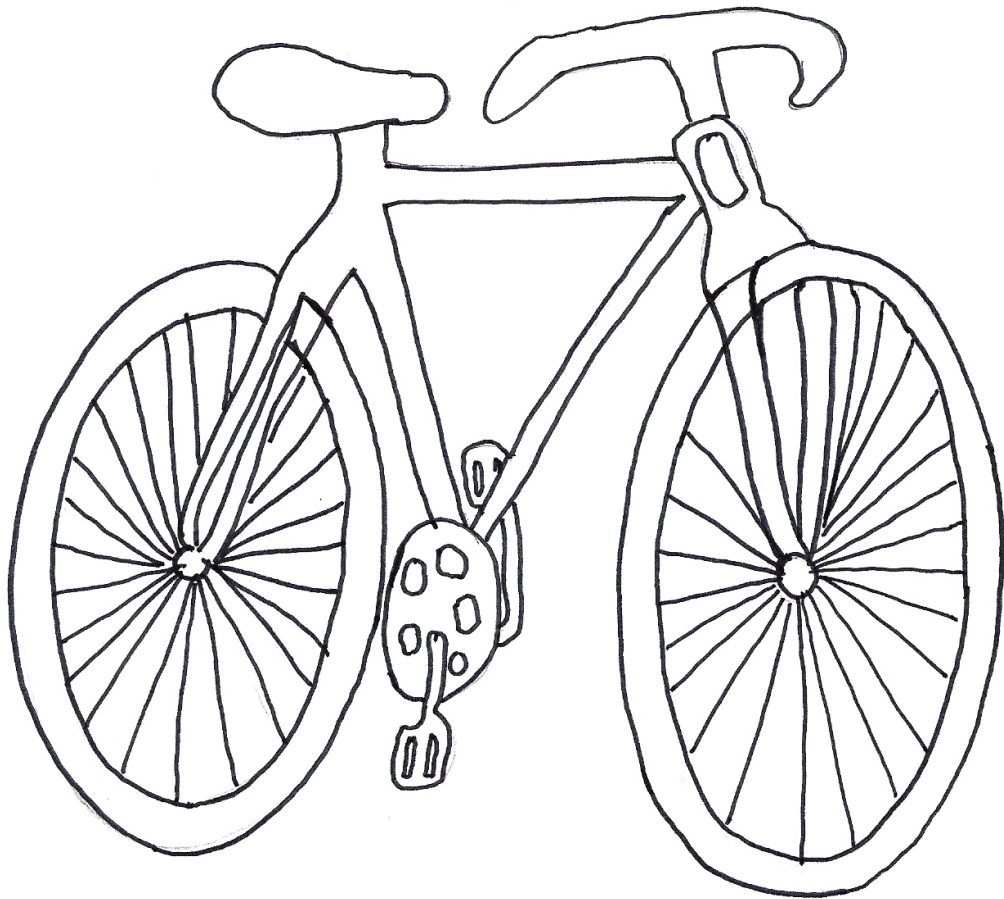

bicicleta

B

b



b **o** **t** **a**

B

b

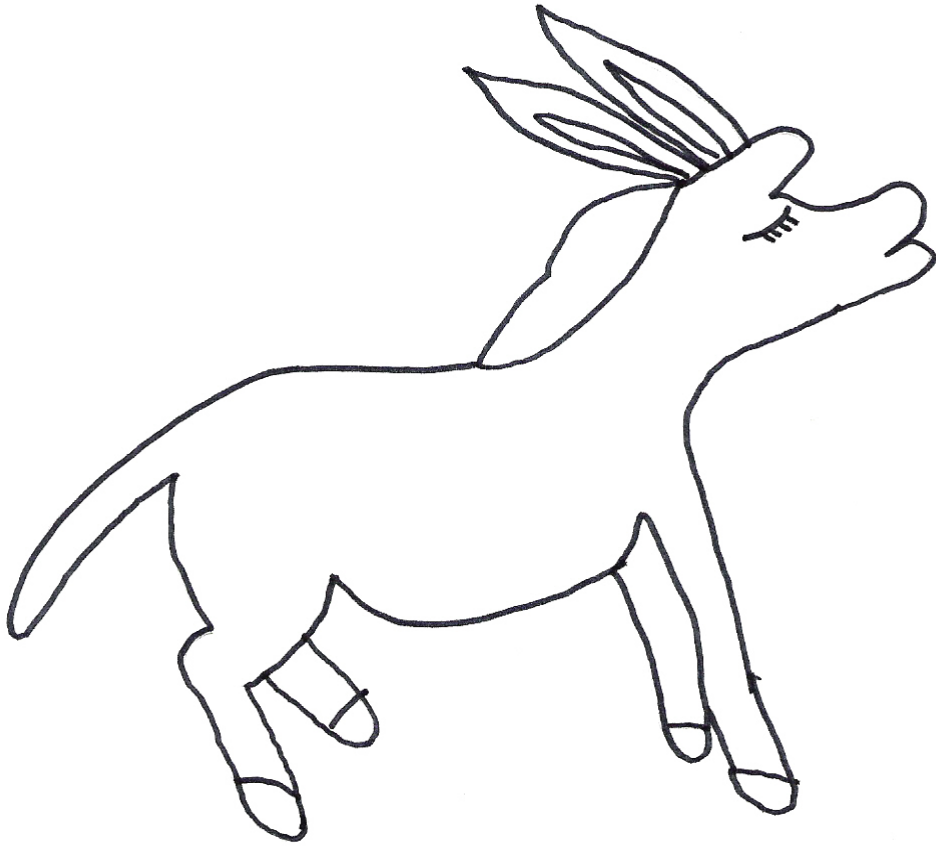

burro

BI

bi



blanca

Bl

bl

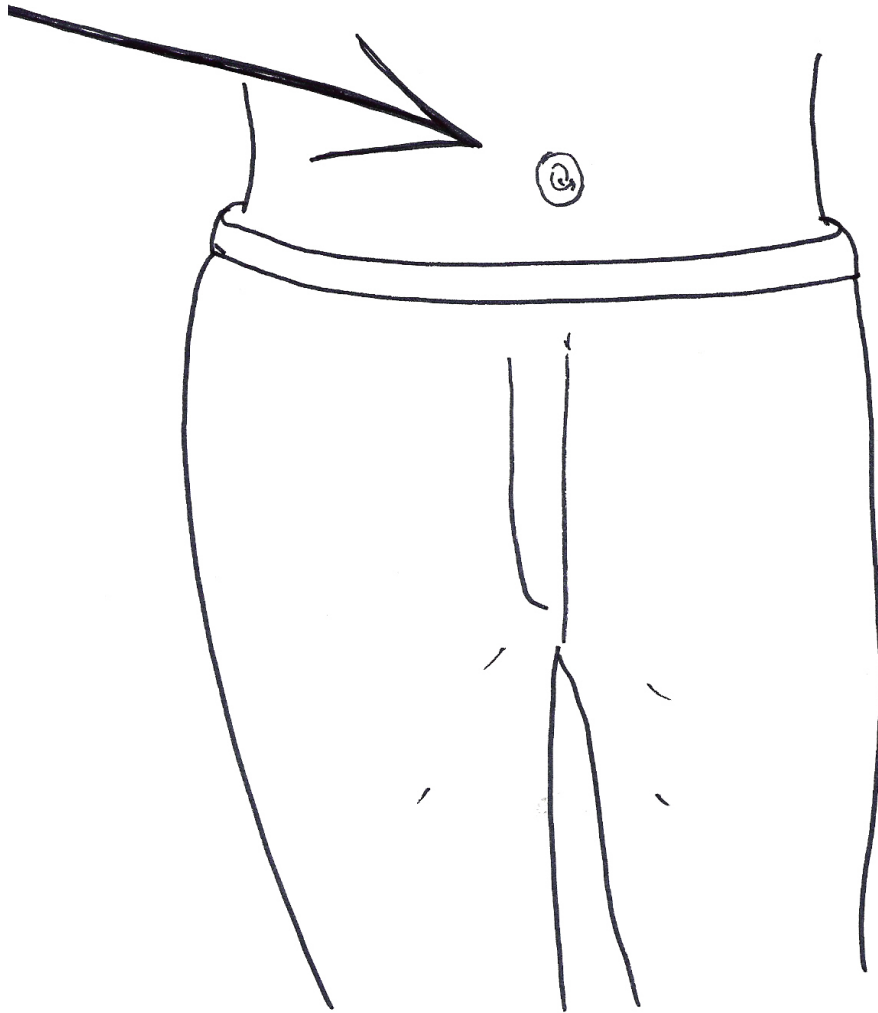

ombliigo

Bl

bl

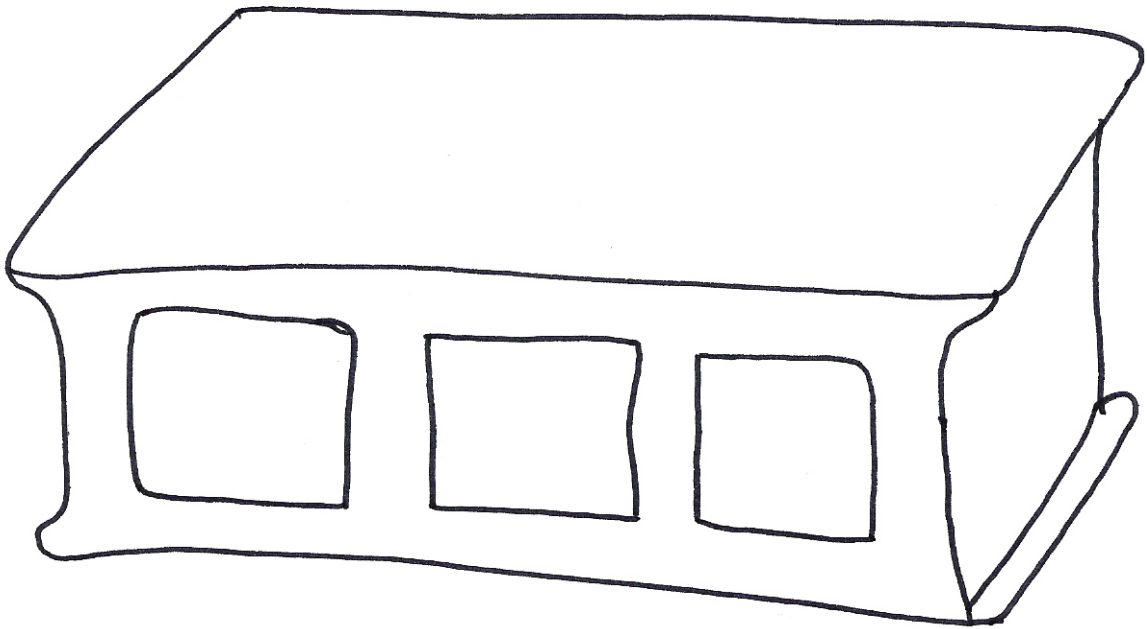

block

Bl

bl



blusa

Br

br



bra**z**o

Br

br

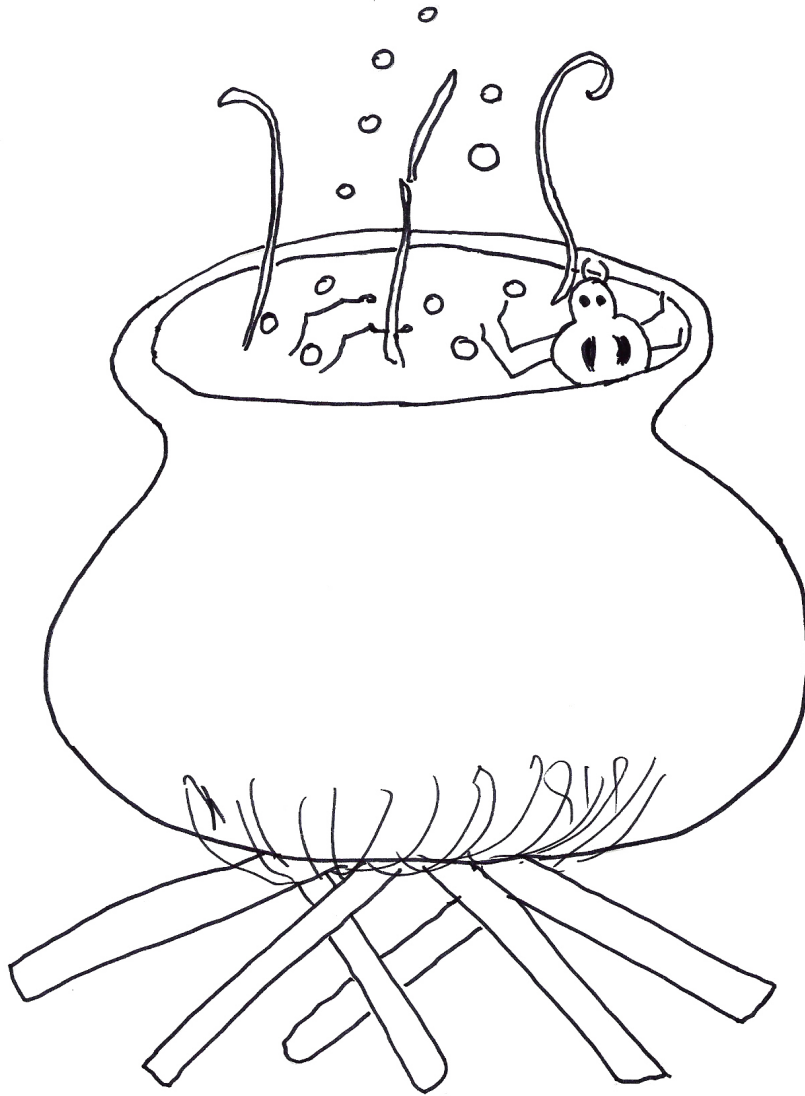

brebaje

Br

br



sombbr**illa**

Br

br



brocha

Br

br



bruja

C

c

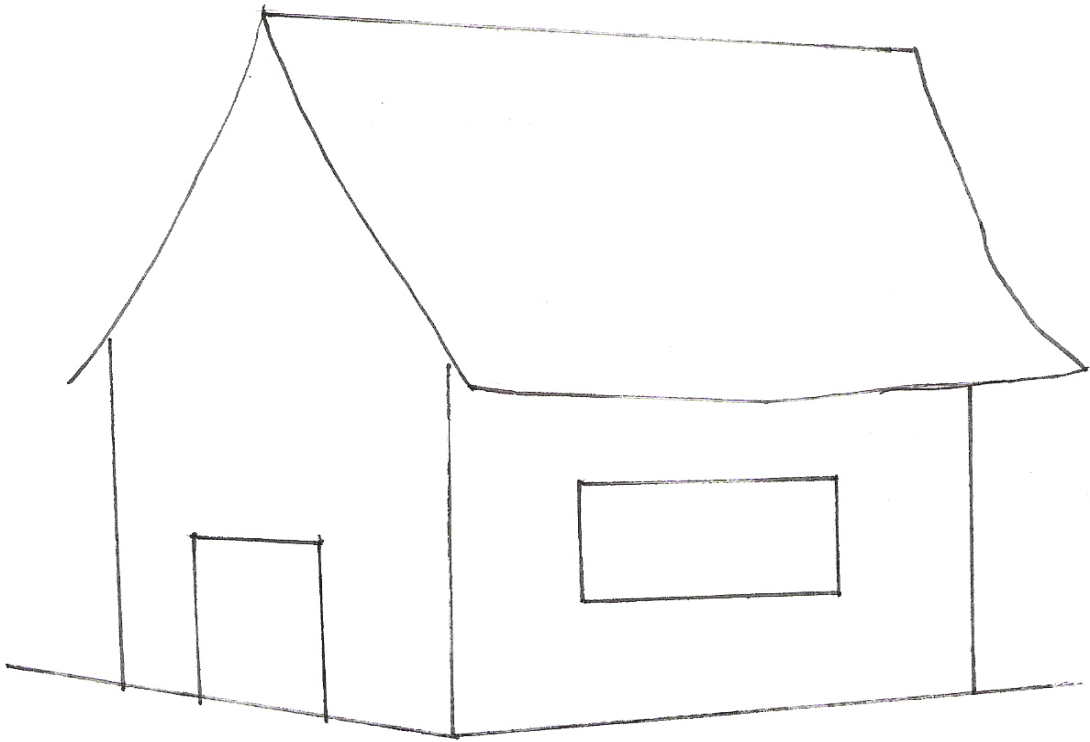

c **a** **s** **a**

C

c

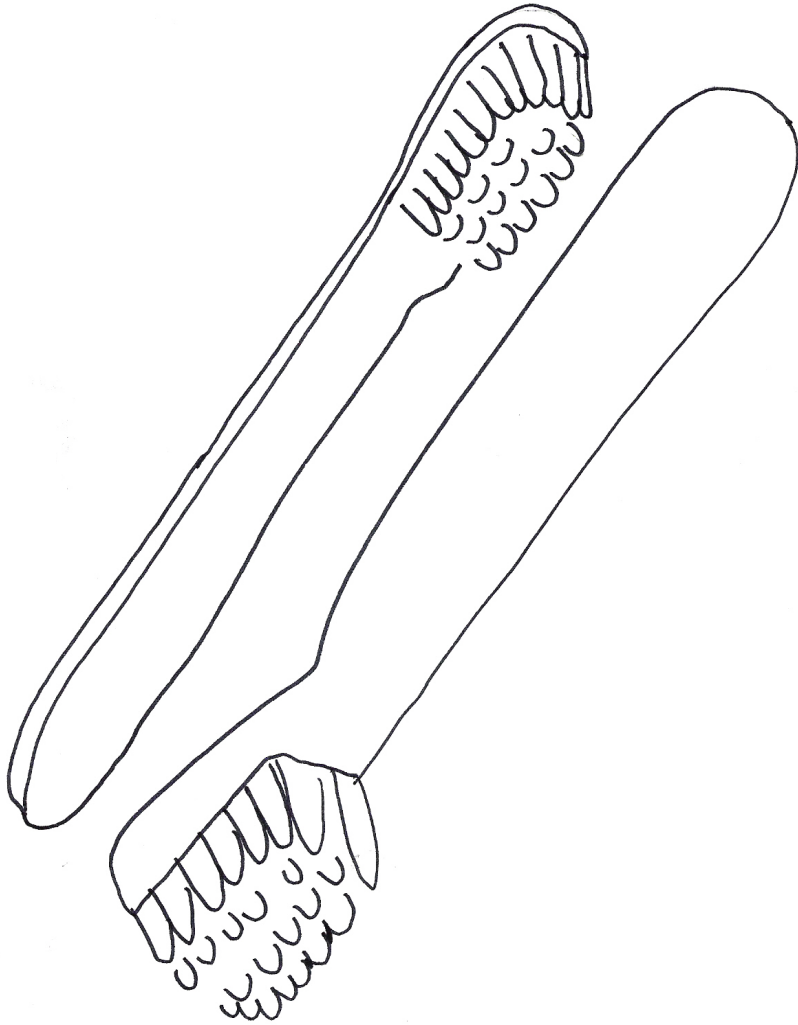

cepillos

C

c

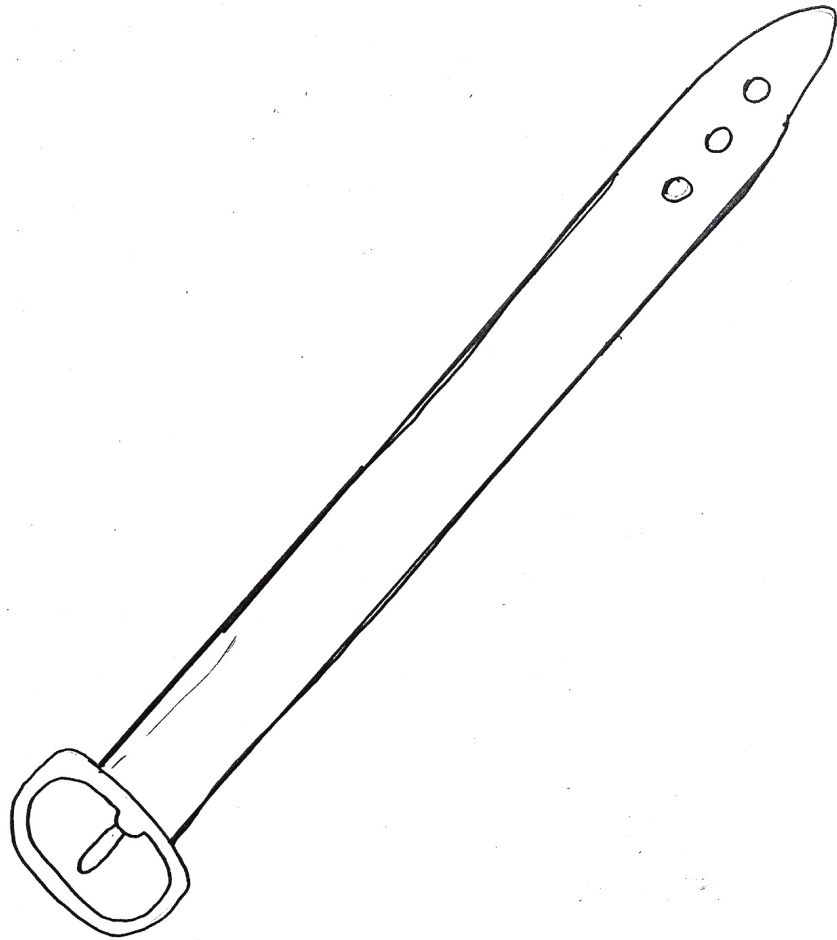

cinto

C

c

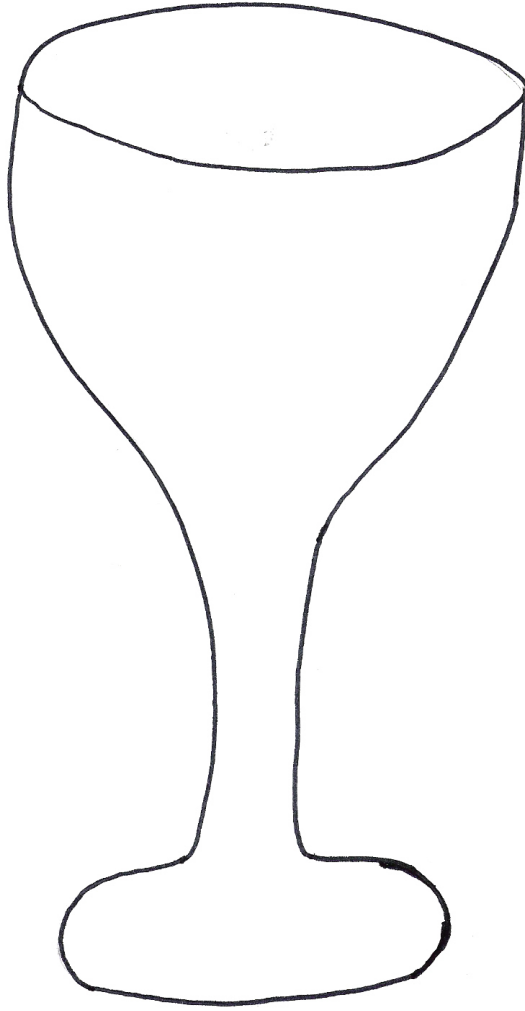

c o p a

C

c

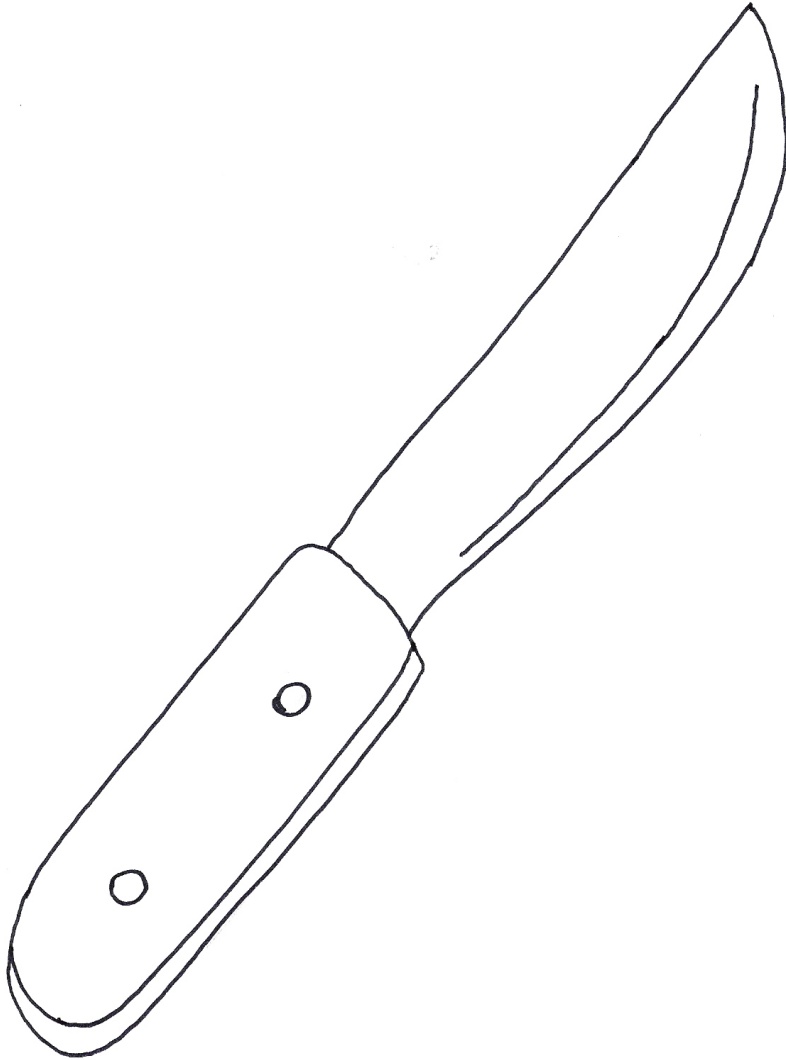

cuchillo

Ch

ch

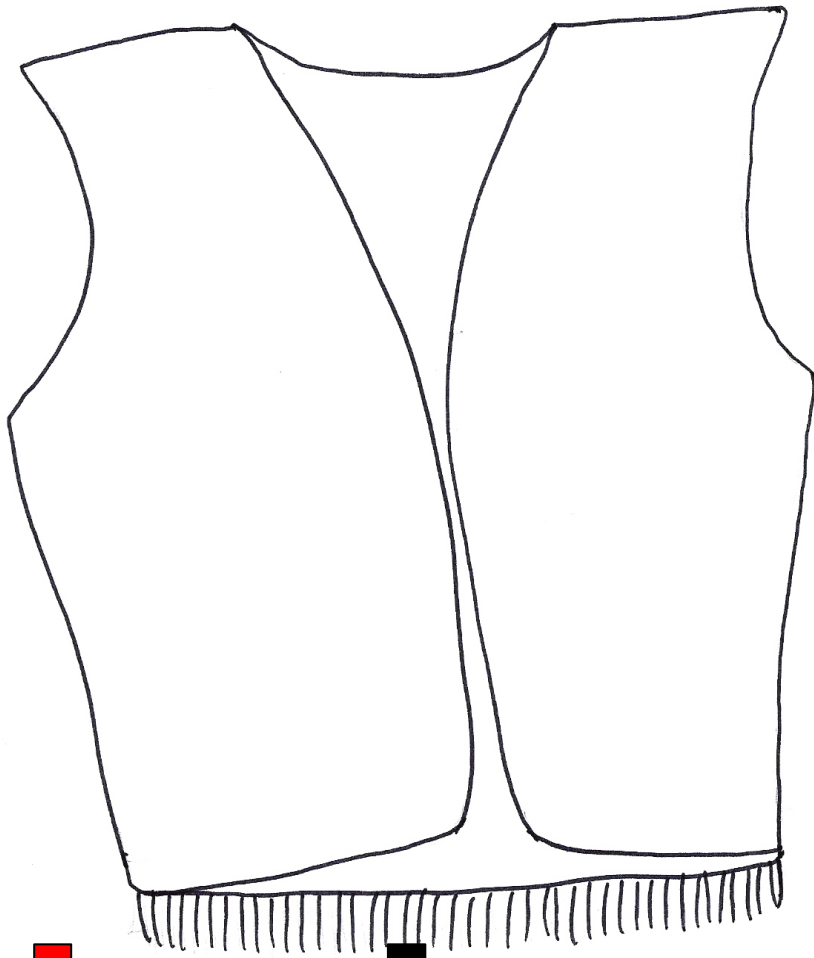

chaleco

Ch

ch



che**l**a

Ch

ch



chile

Ch

ch



chocolate

Ch

ch

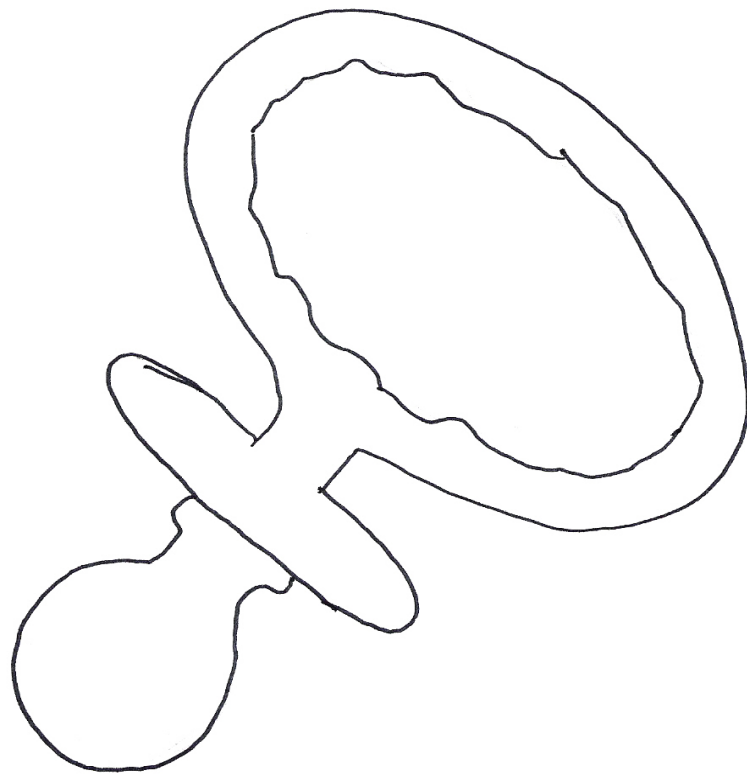

chupón

cl

cl



clavo

C

c

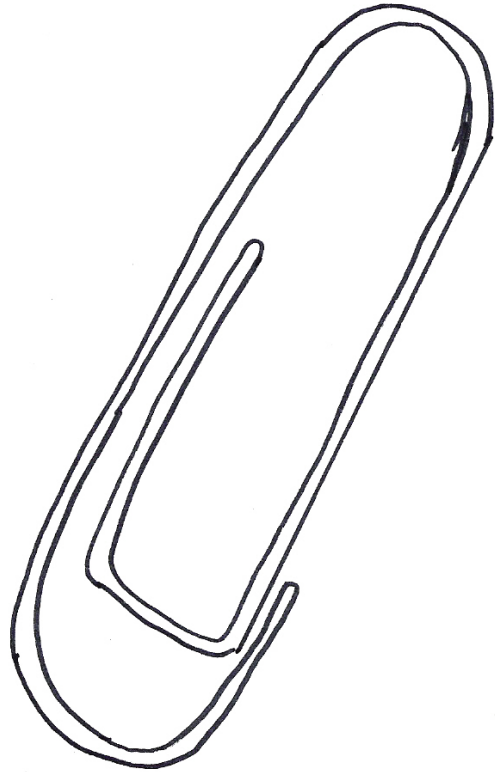

clip

C

c

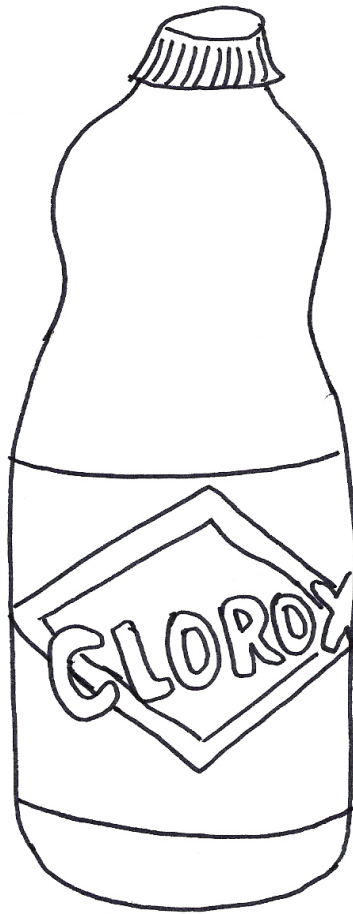

cloro

Cr

cr

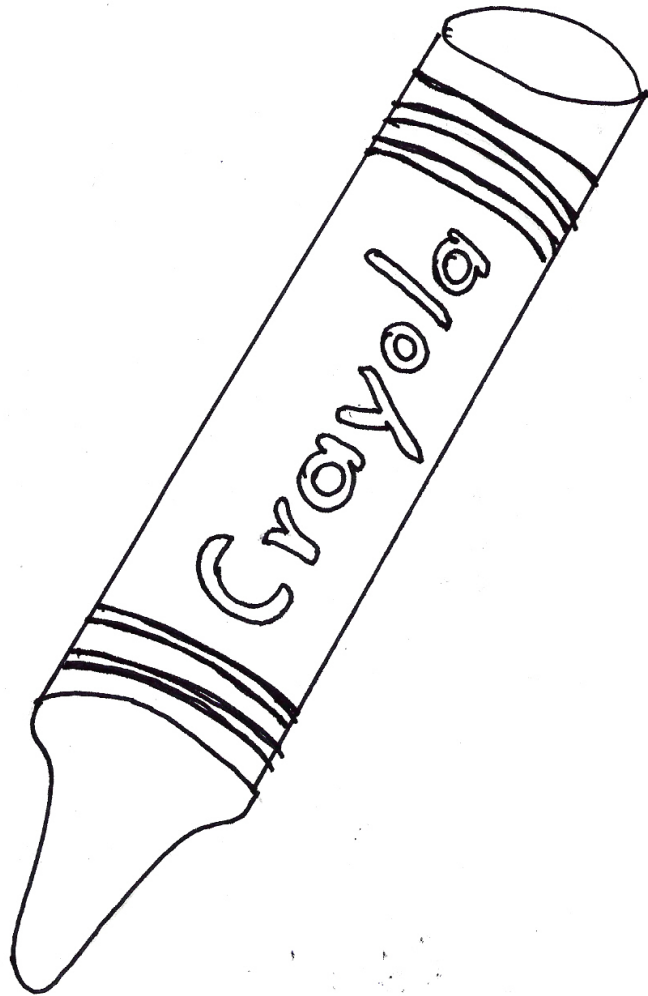

crayola

Cr

cr

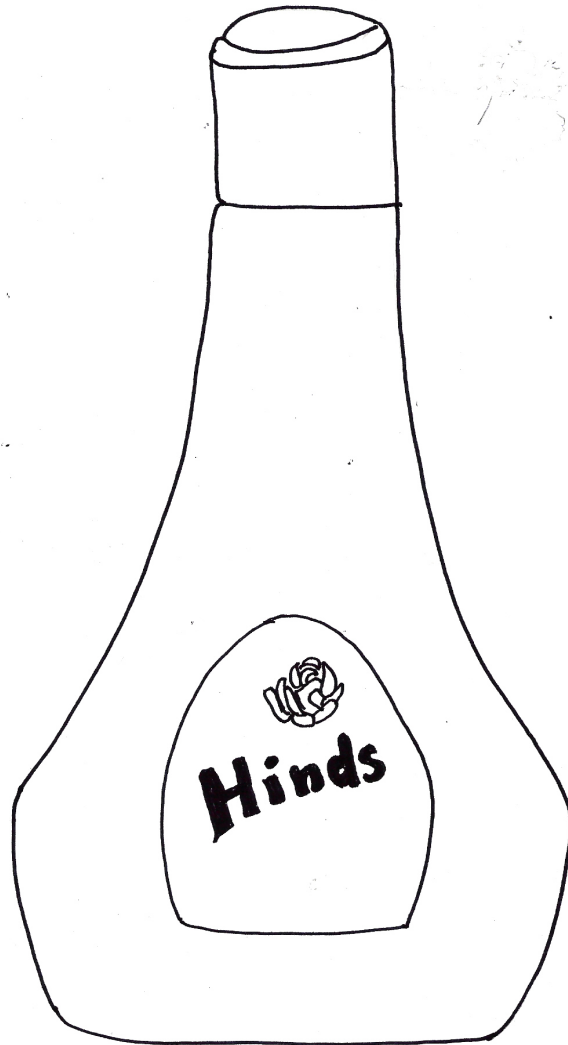

crema

Cr

cr

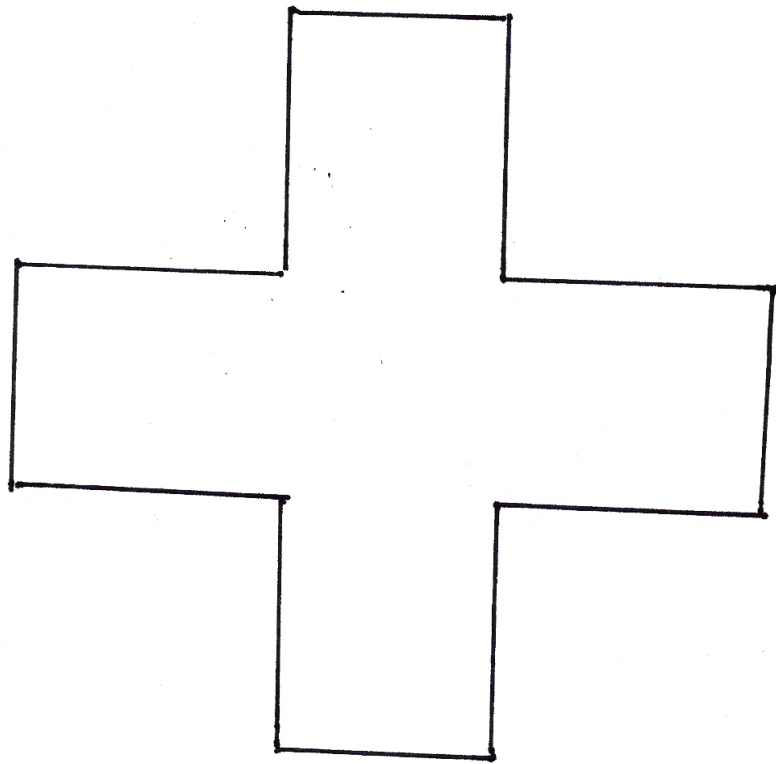

cruz

D

d

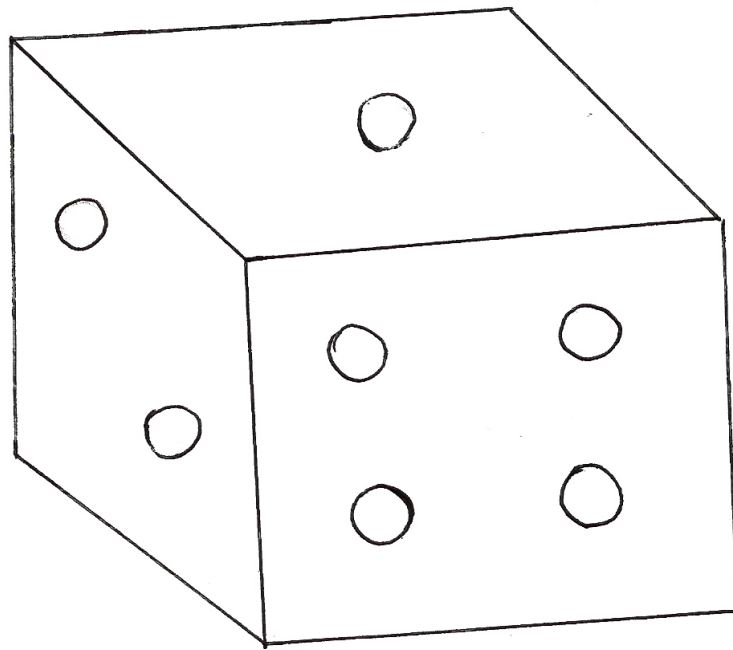

dadado

D

d

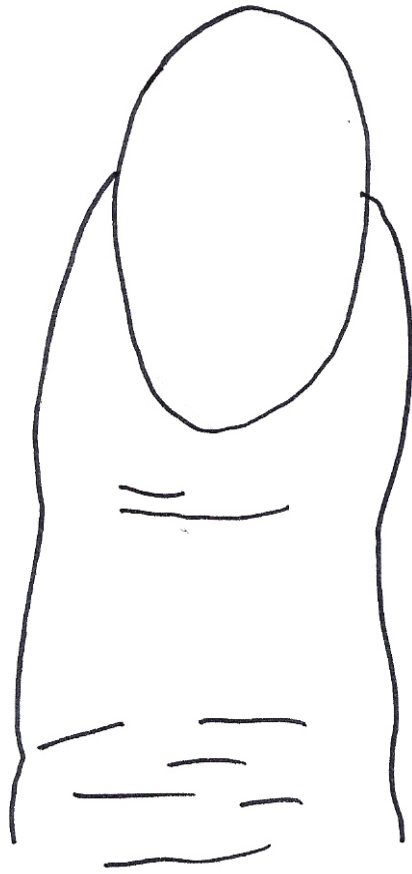

dedo

D

d

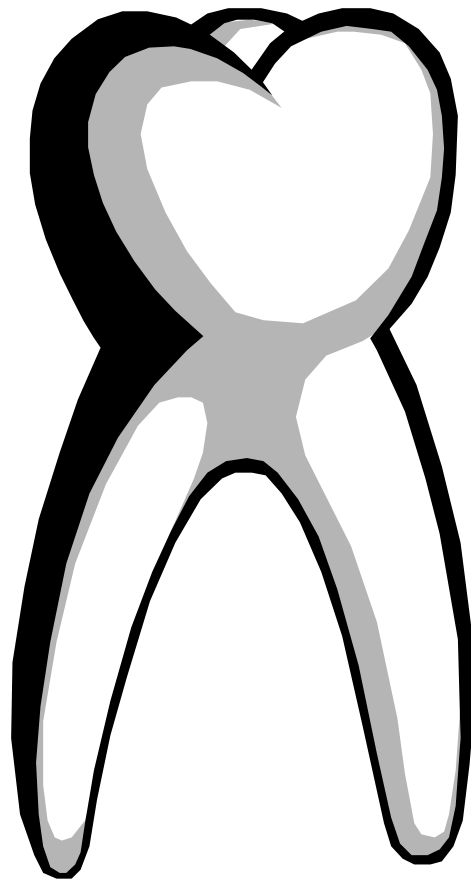

diente

D

d

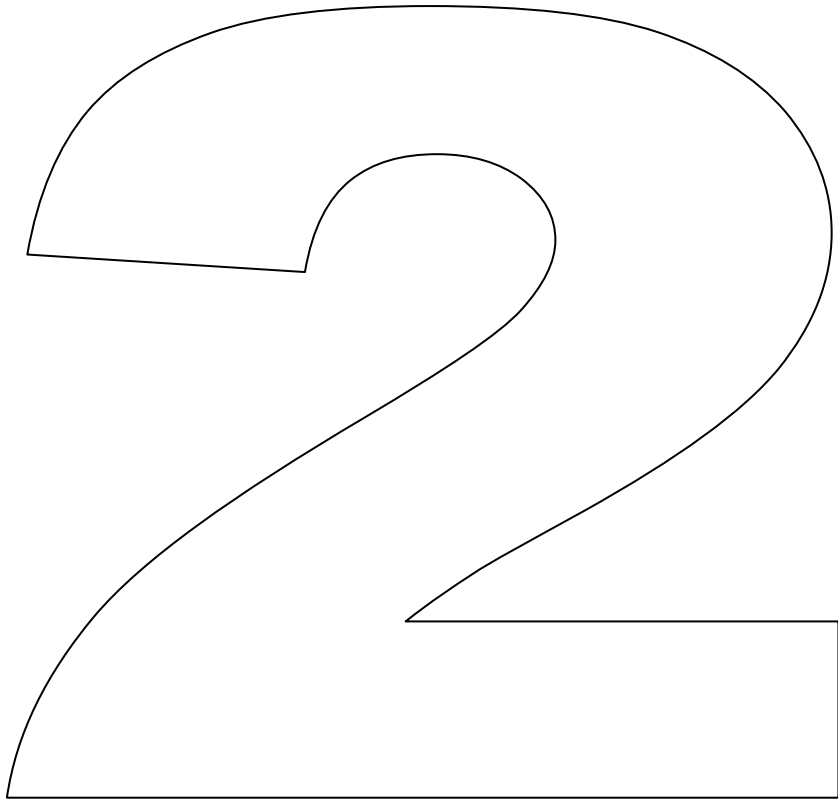

dos

D

d



dulce

Dr

dr



dragón

Dr

dr

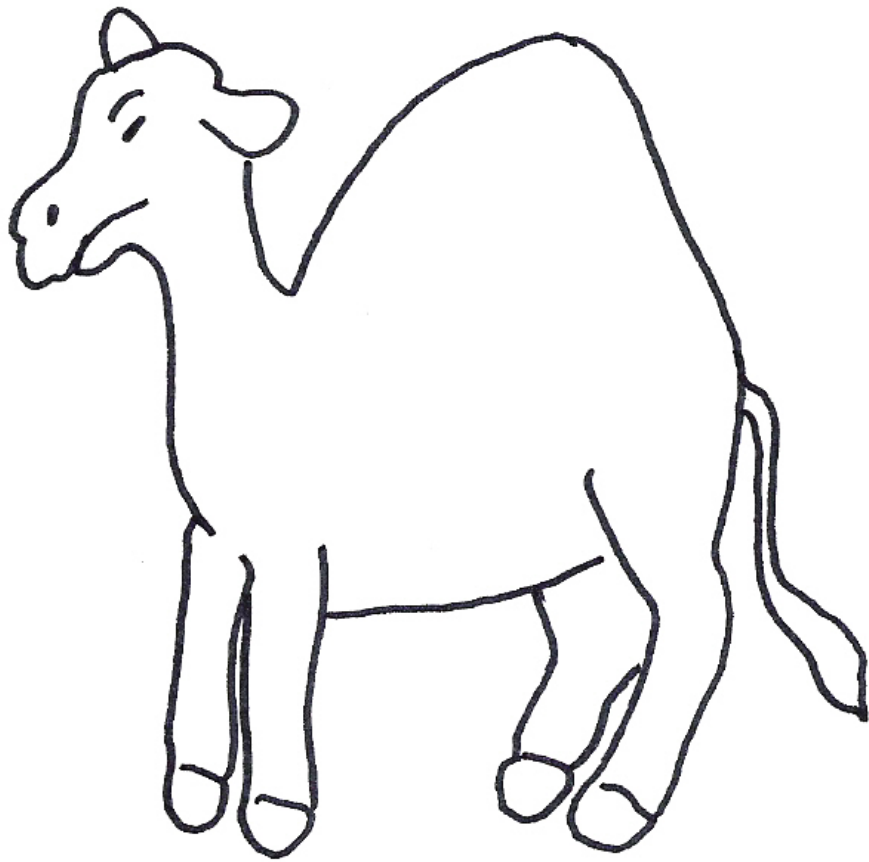

dromedario

E

e

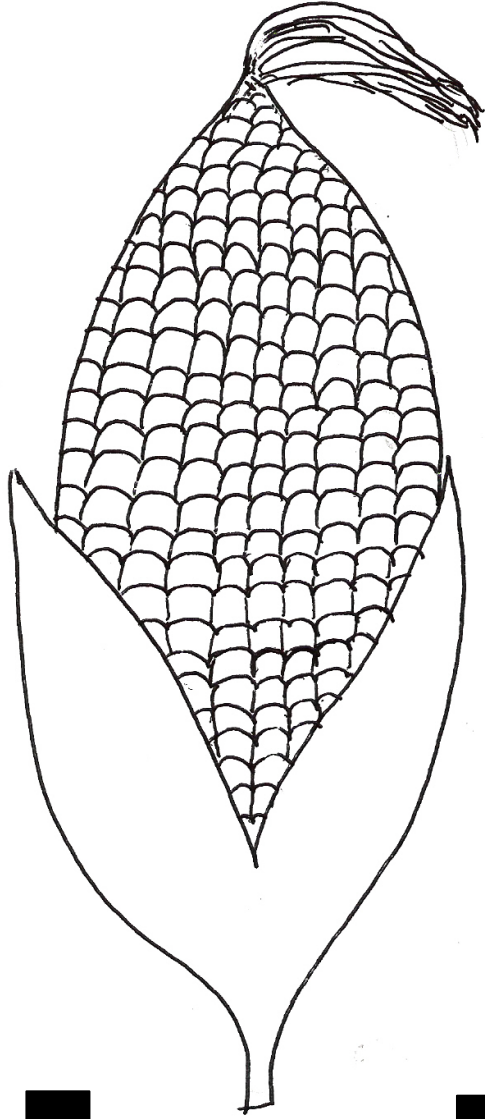

elote

En

en

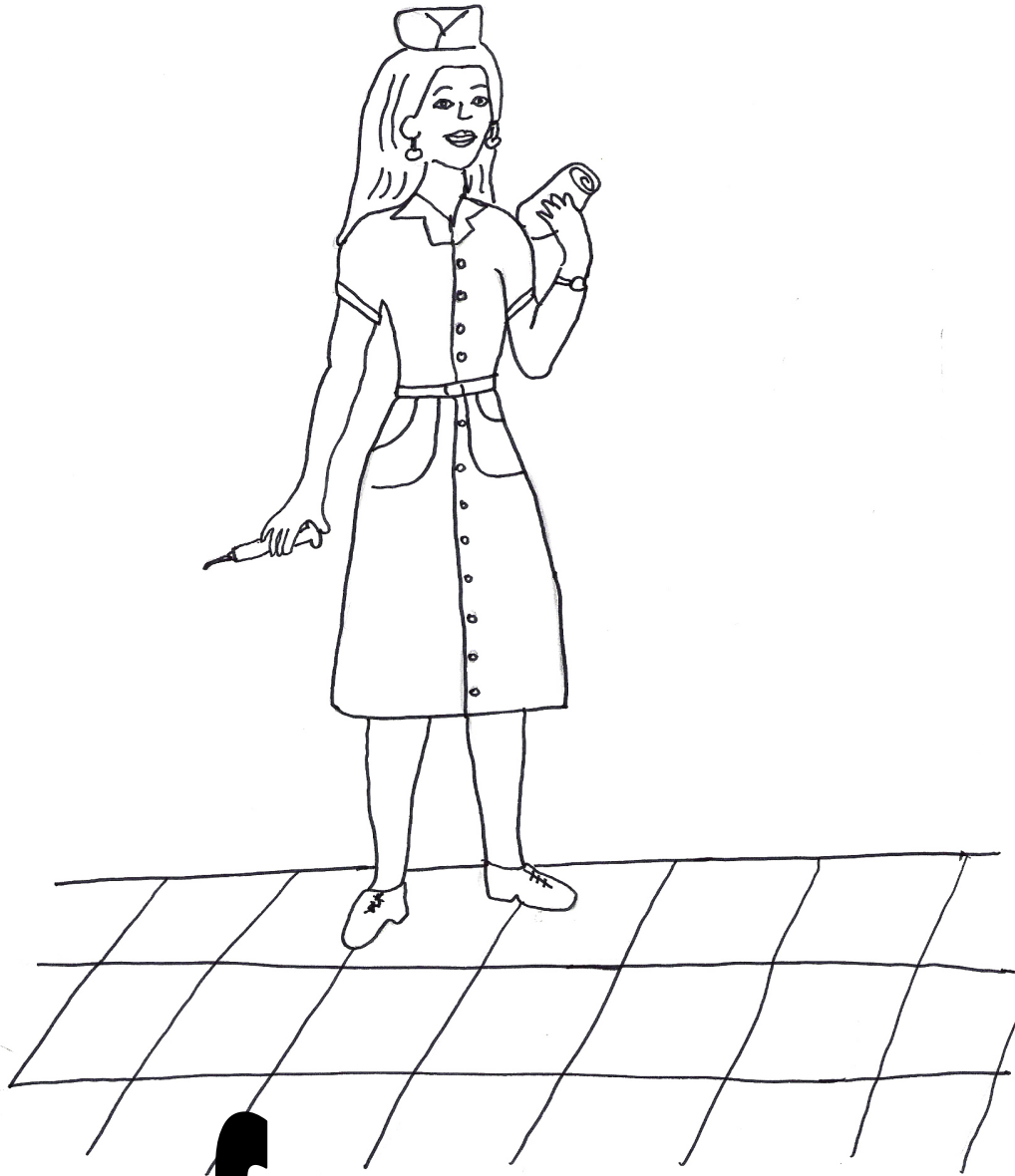

enfermera

Es

es

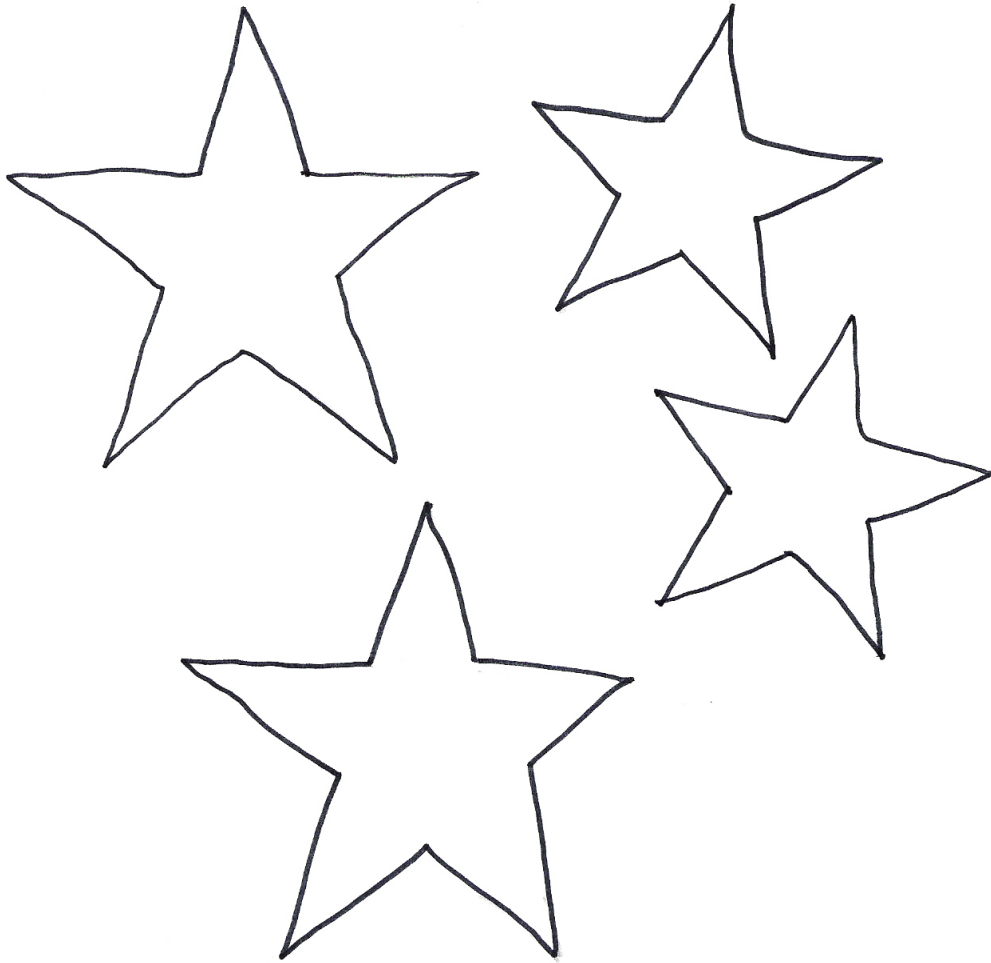

estrella

F

f



fantasma

F

f

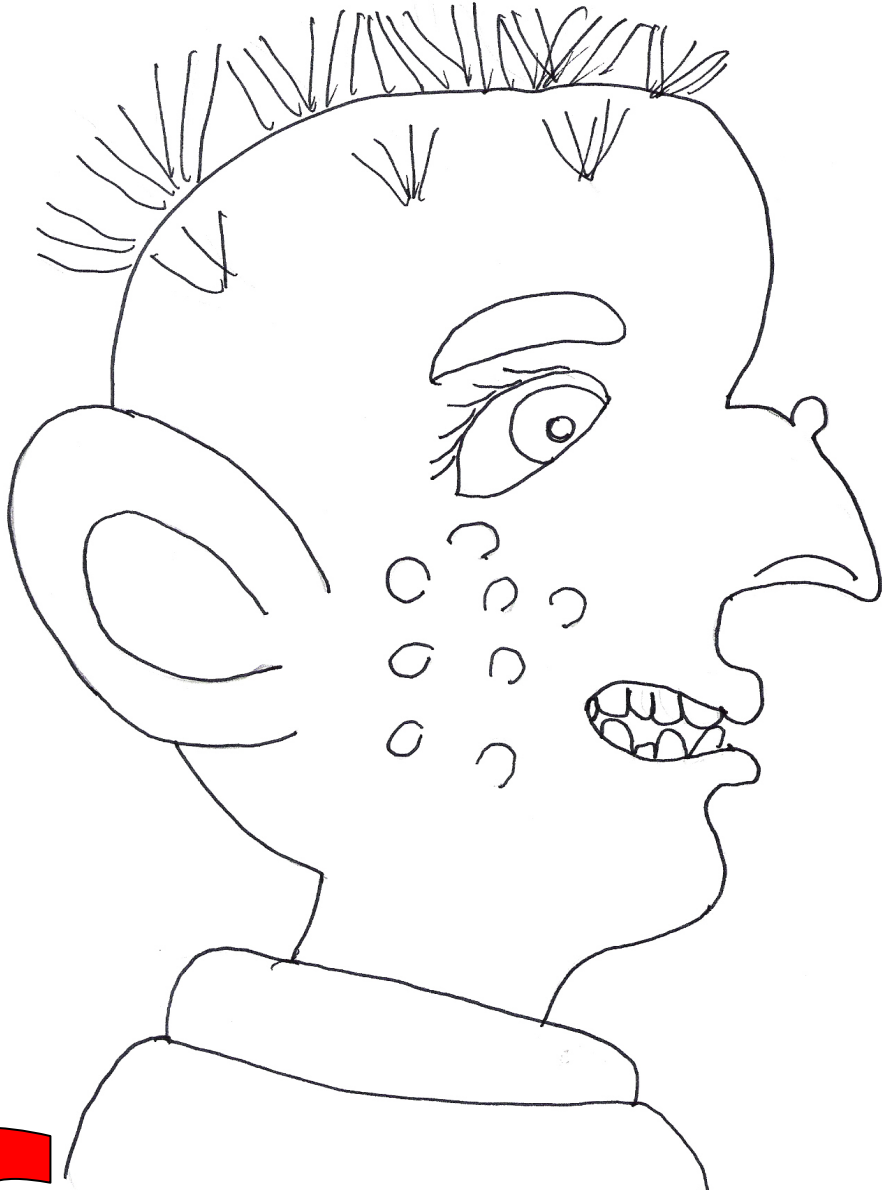

f **e** **o**

F

f

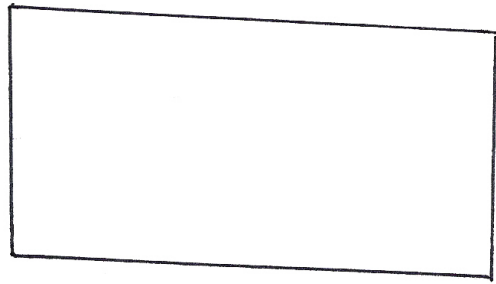
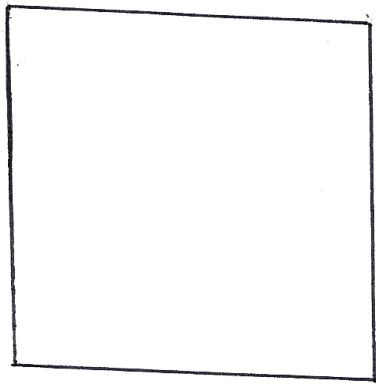
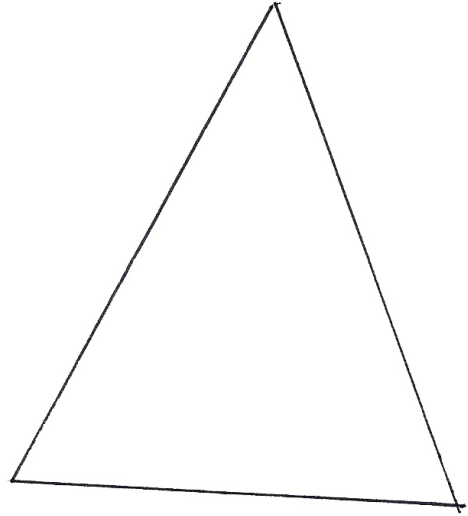
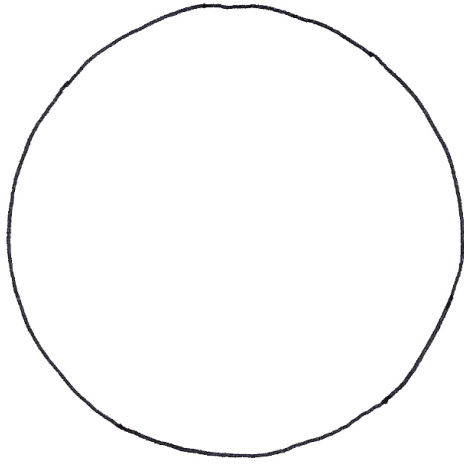

figuras

F

f

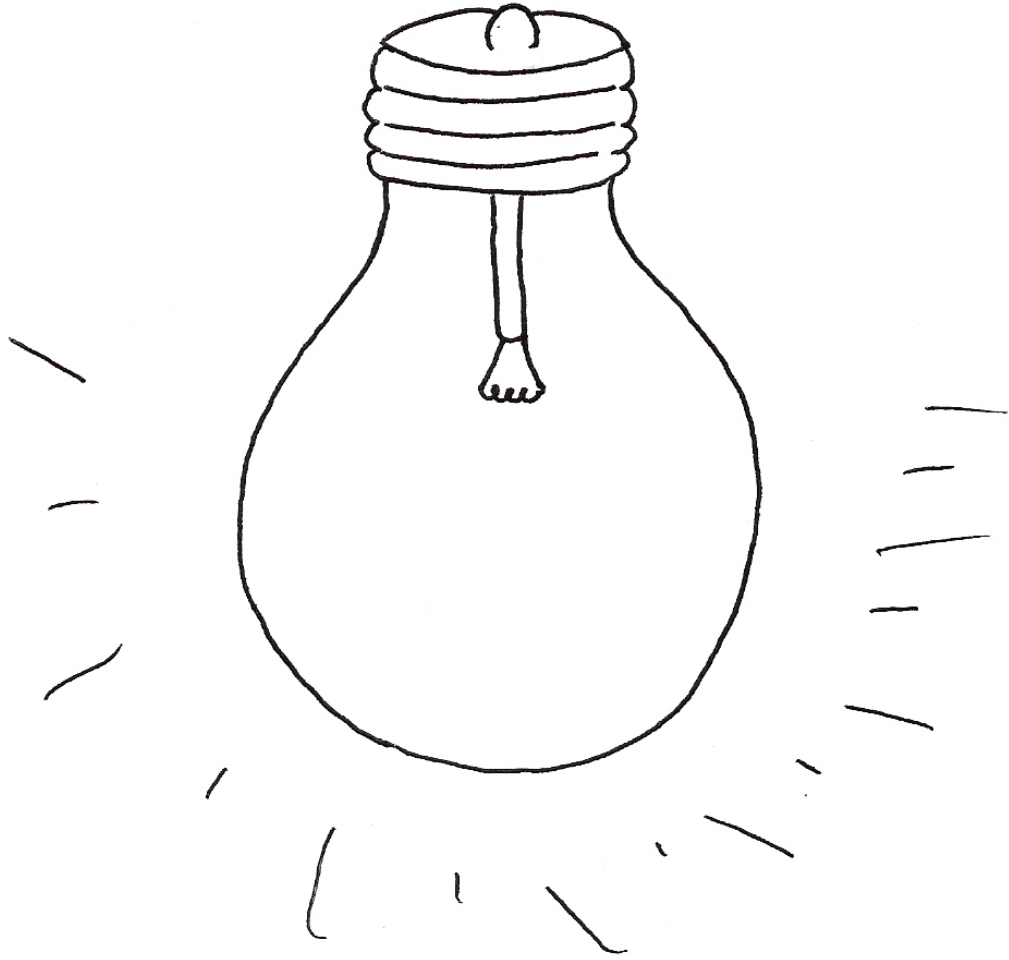

fo**cc**o

F

f

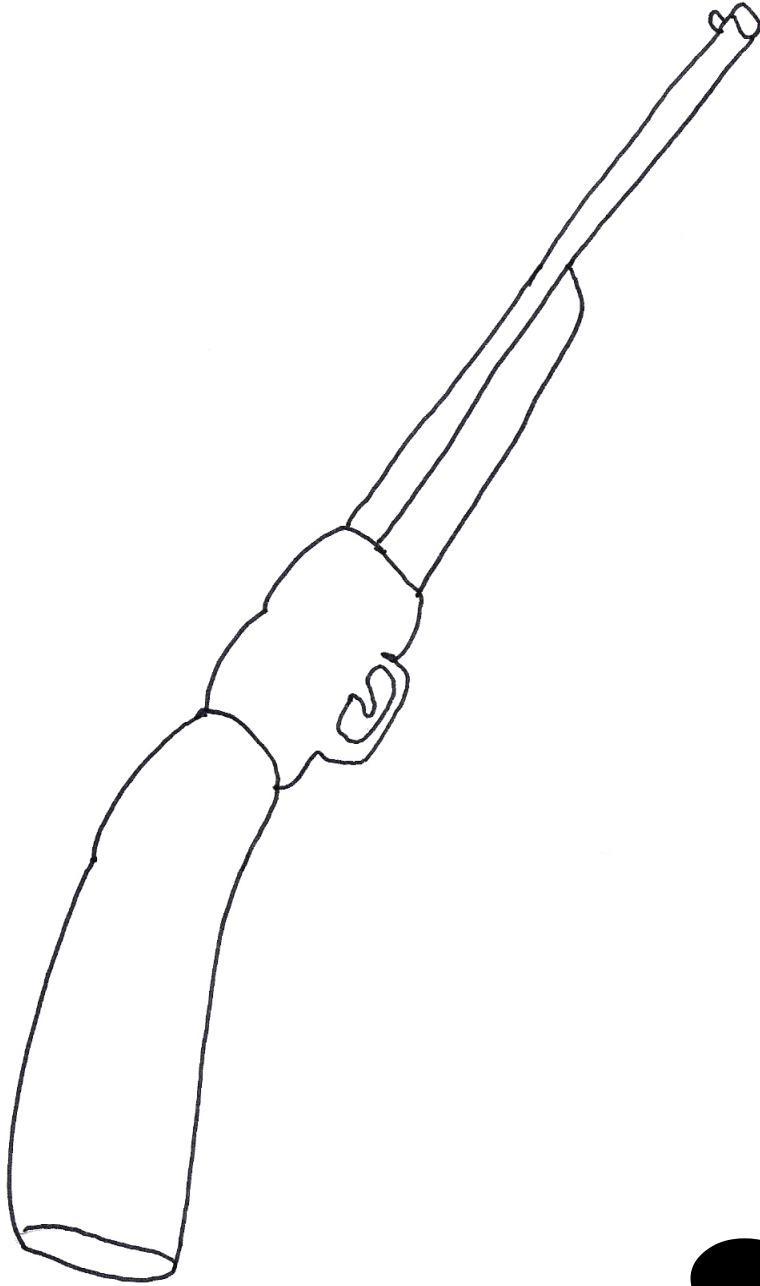

f **u** **s** **i** **l**

Fl

fl

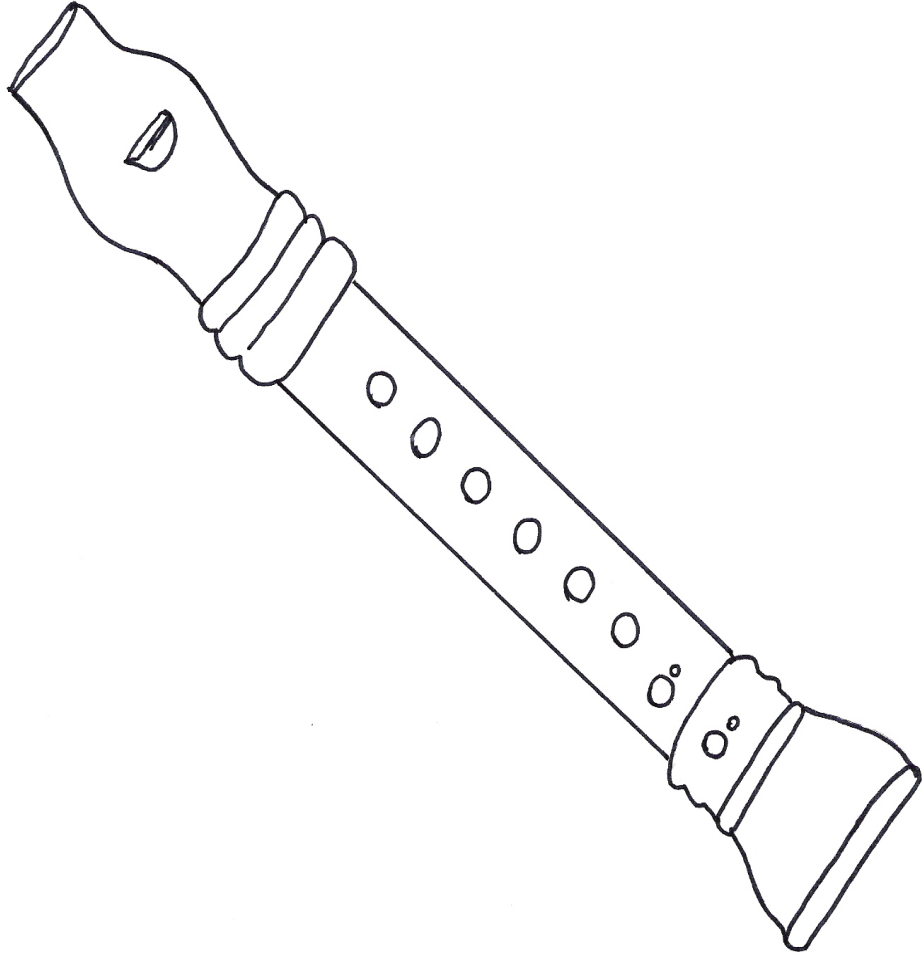

flauta

Fl

fl

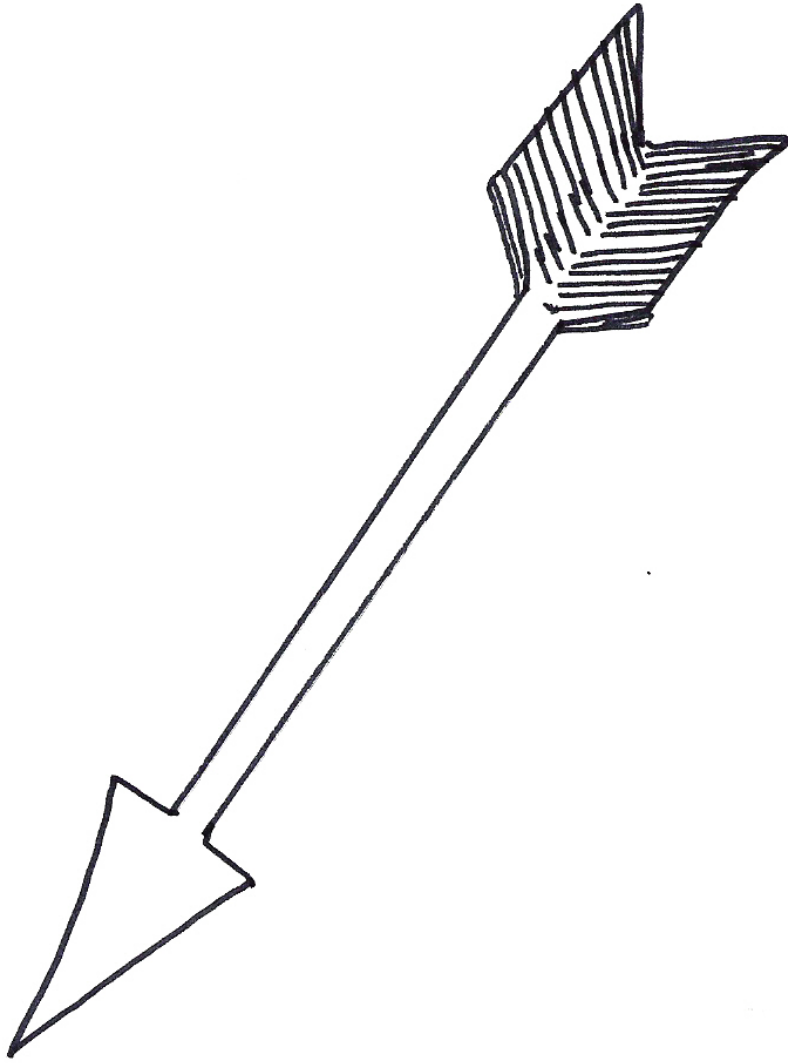

flecha

Fl

fl



flores

Fr

fr

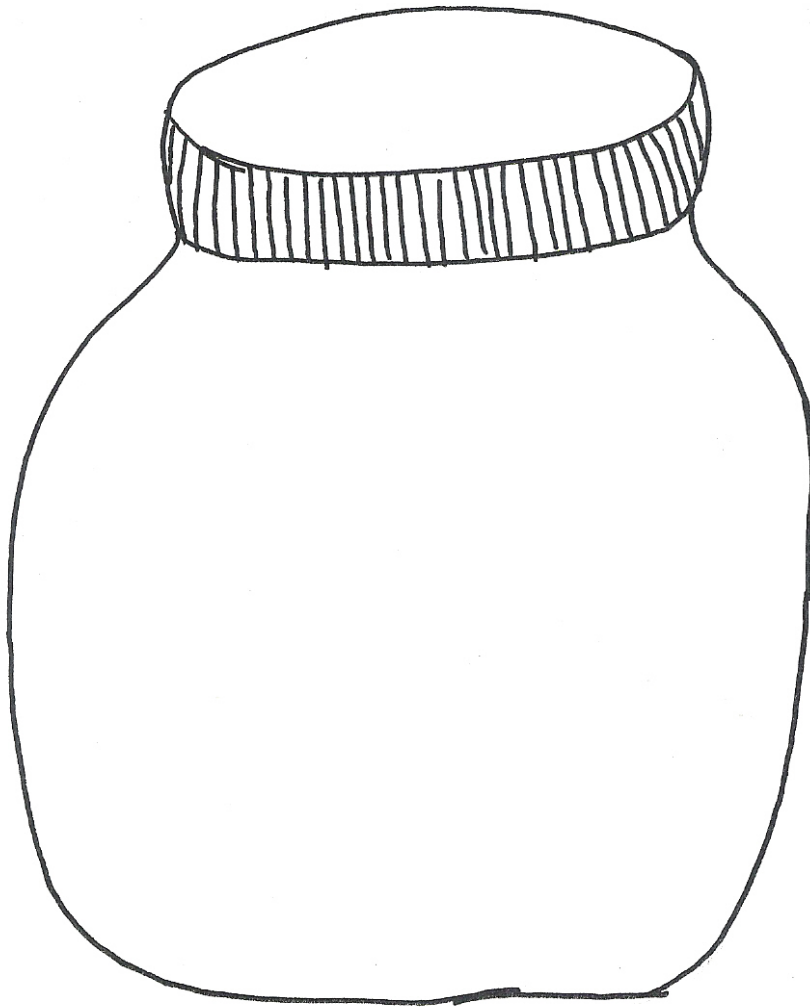

frasco

Fr

fr

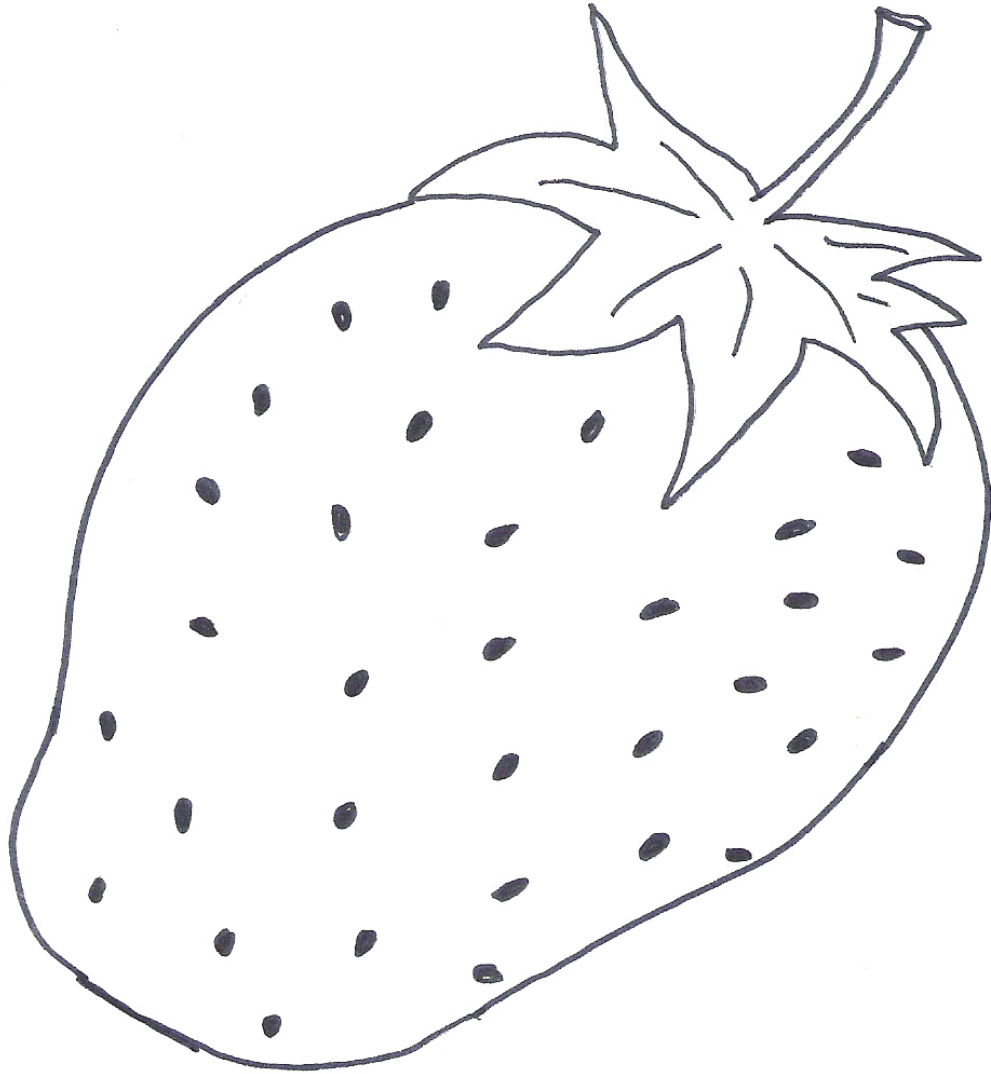

fresa

Fr

fr

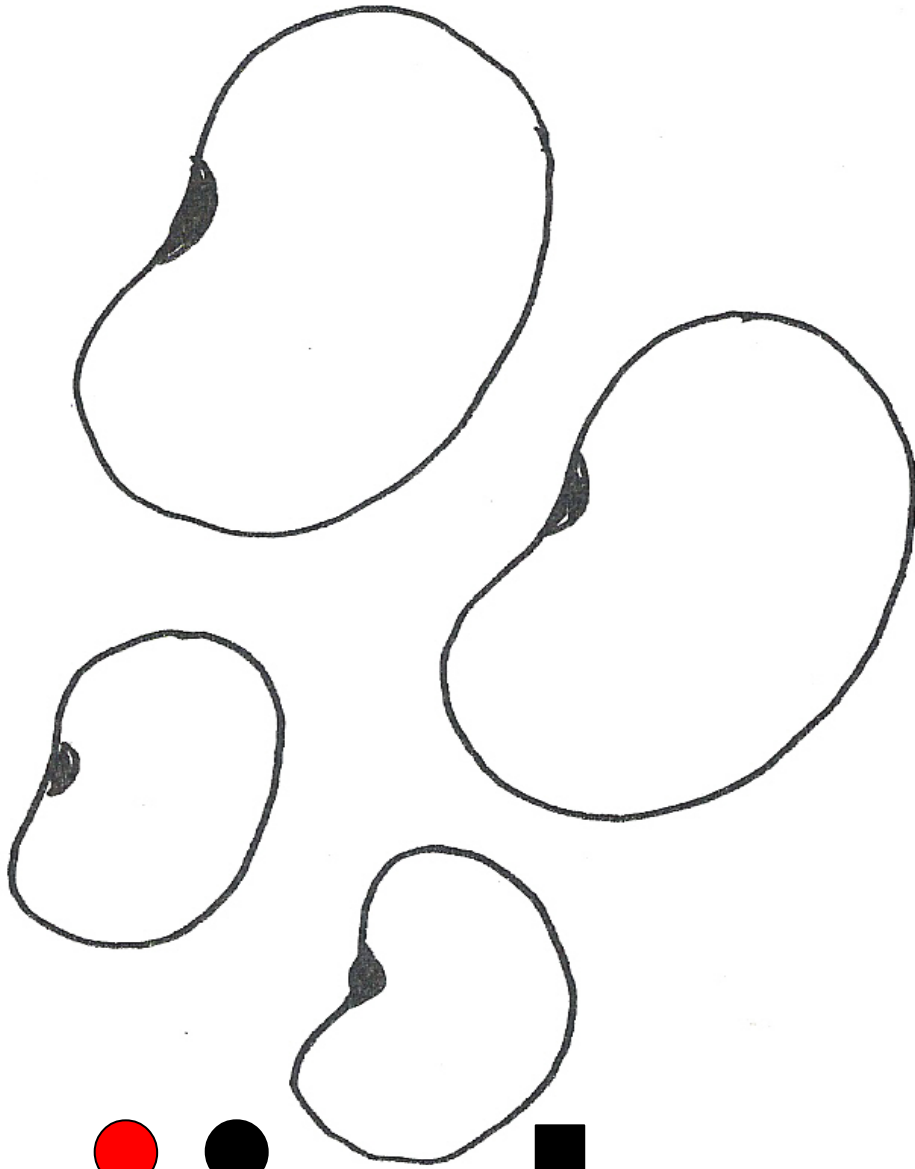

frijoles

Fr

fr

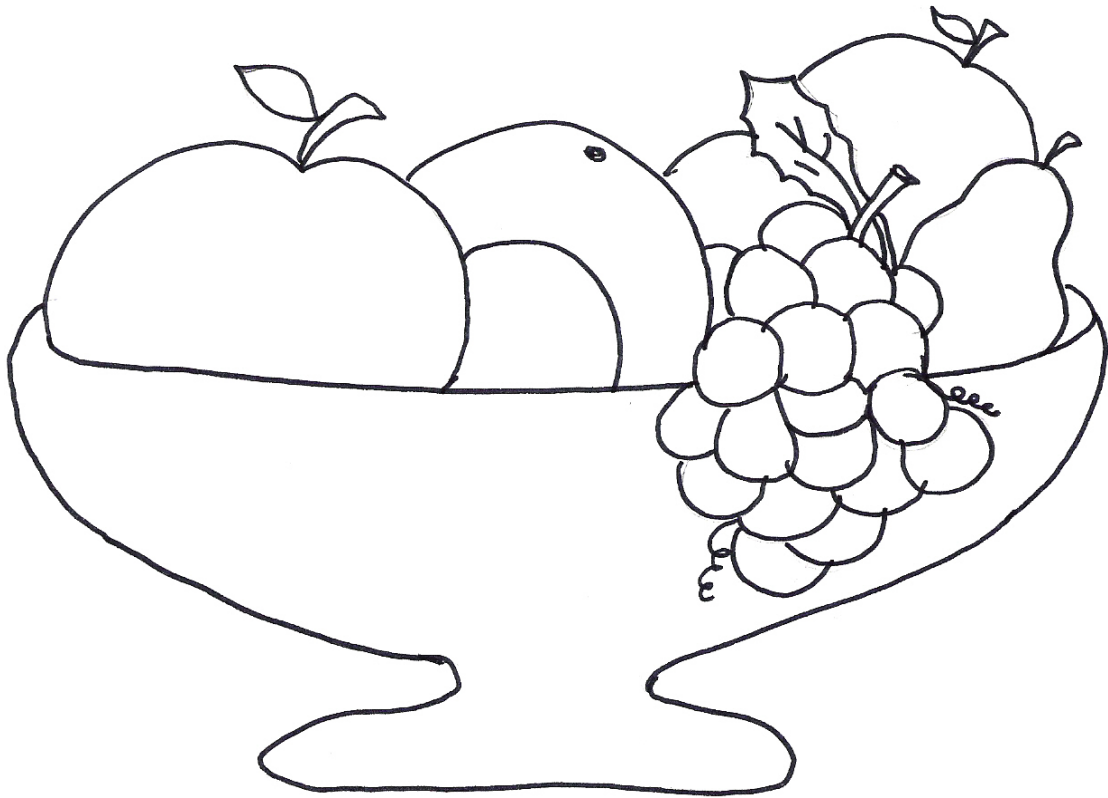

frutero

G

g

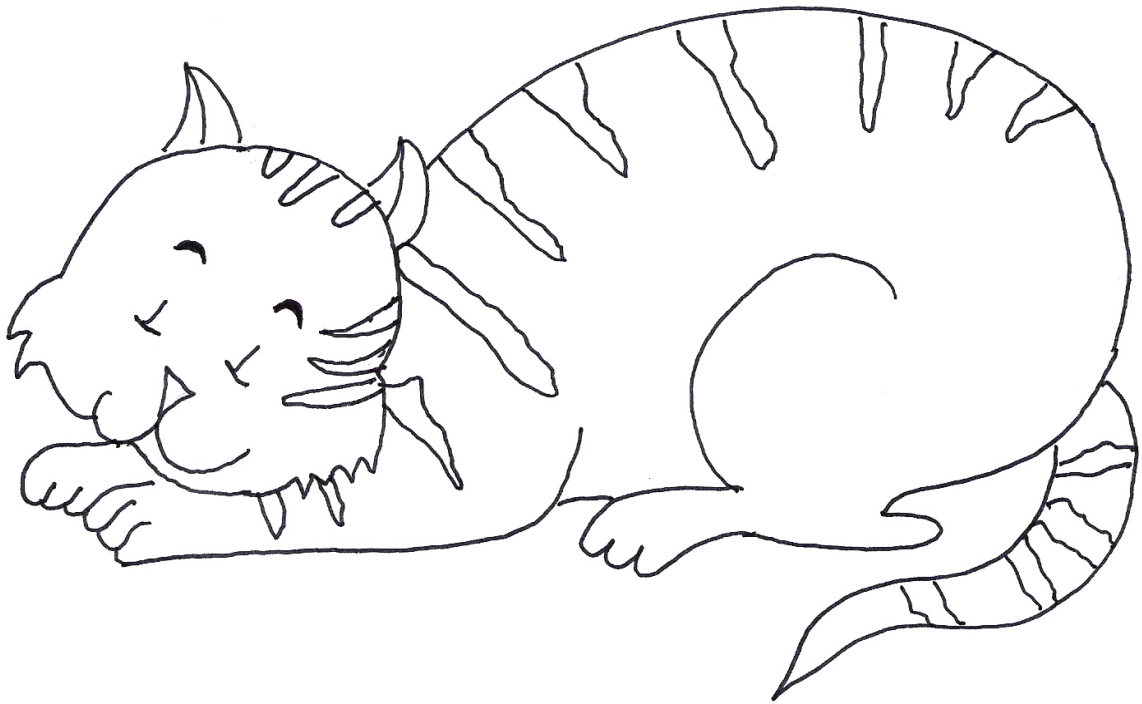

gato

G

g

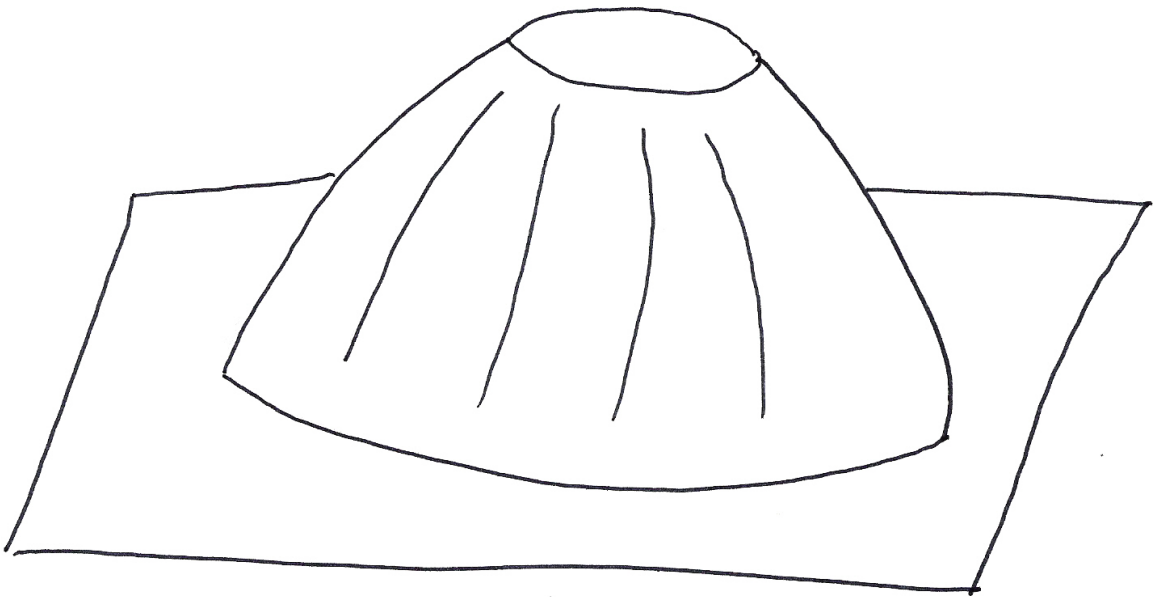

gelatina

G

g

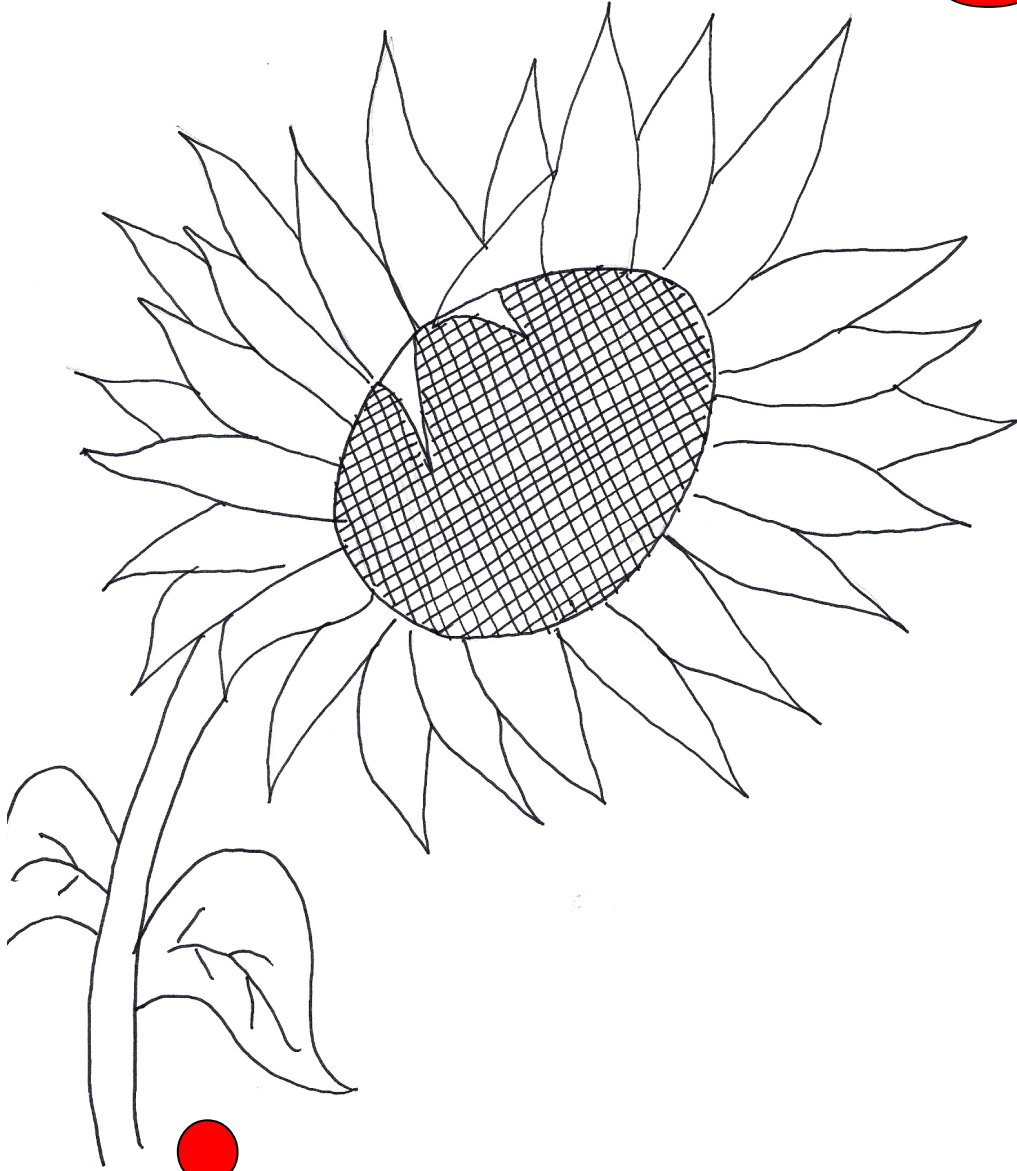

girasol

G

g

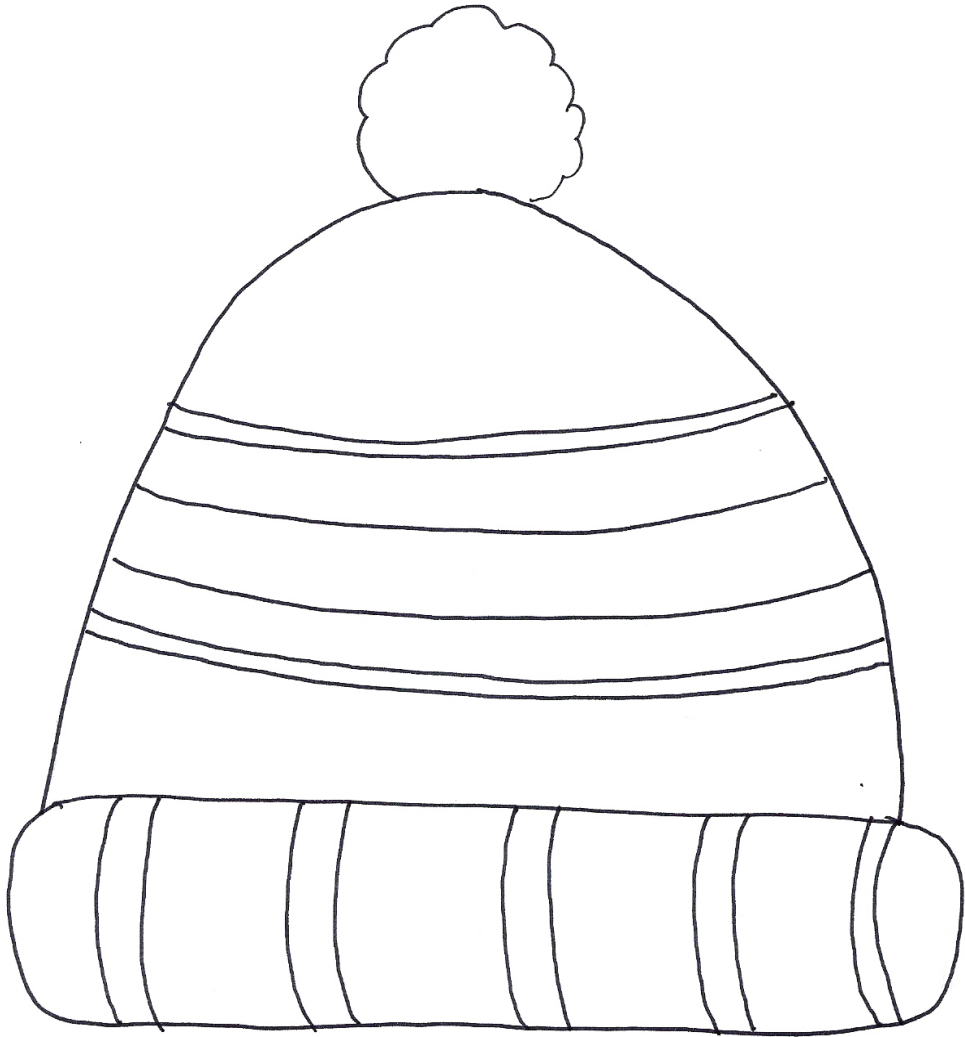

gorra

G

g

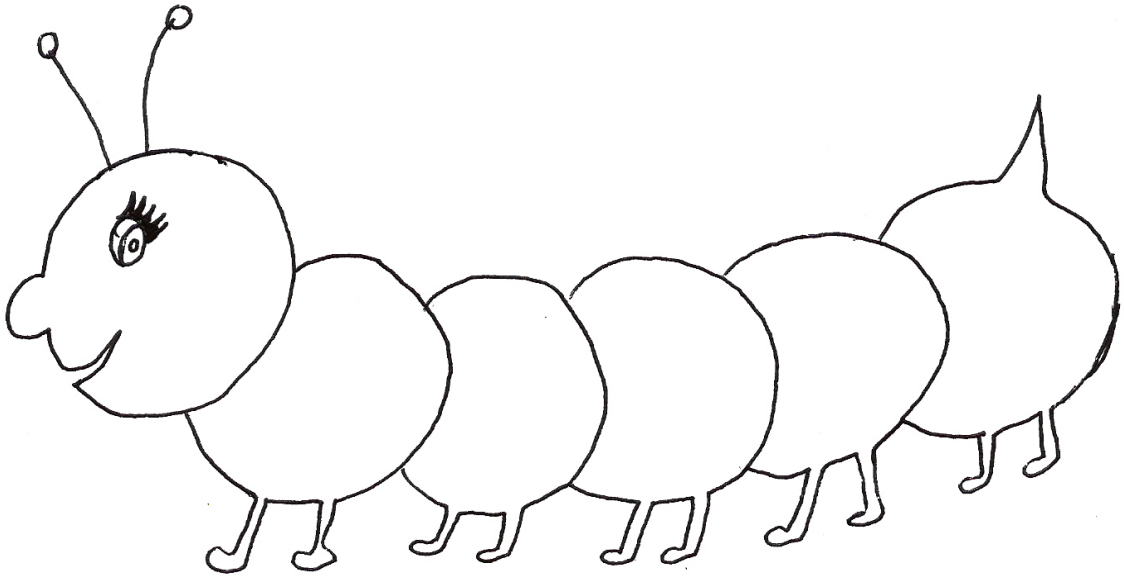

gusano

Gl

gl

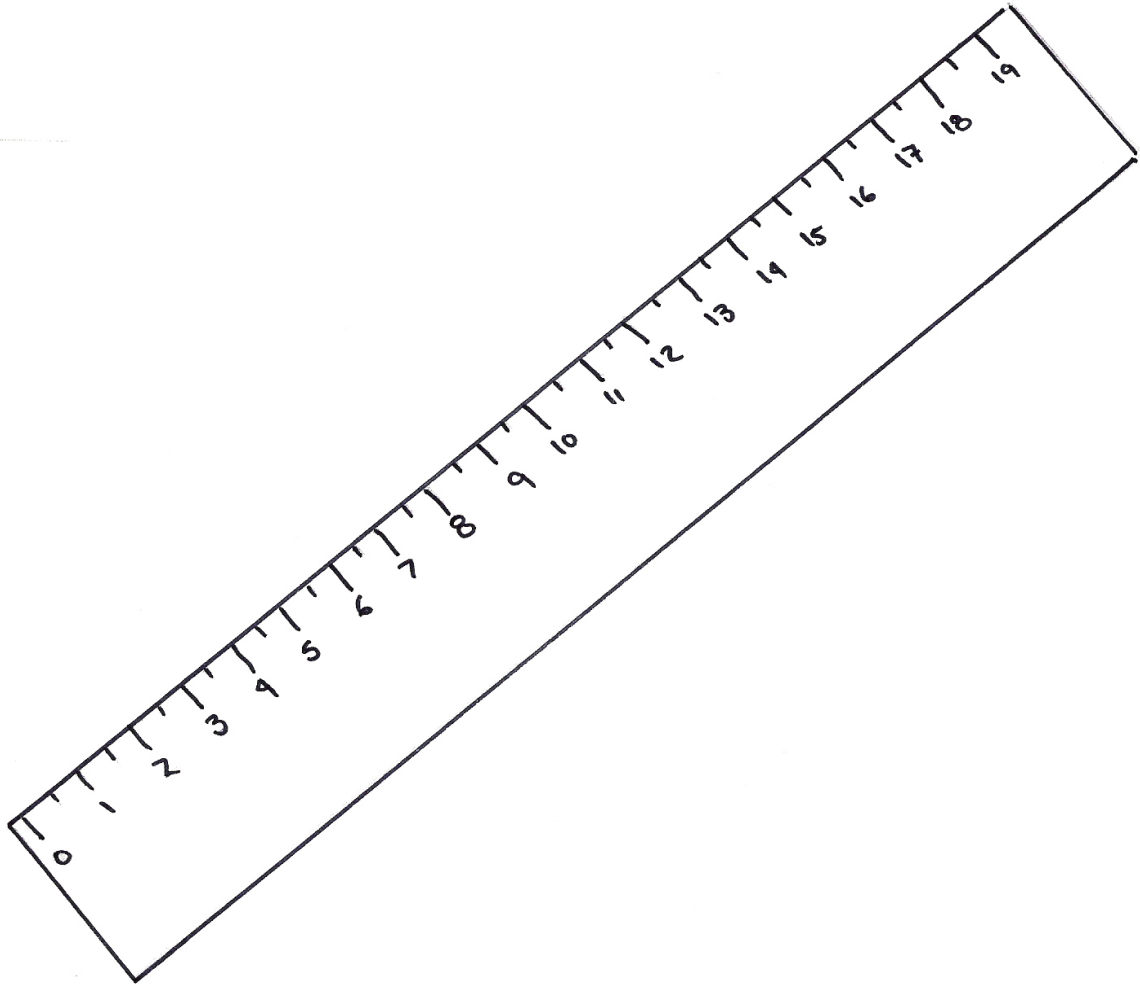

re**gl****a**

Gl

gl

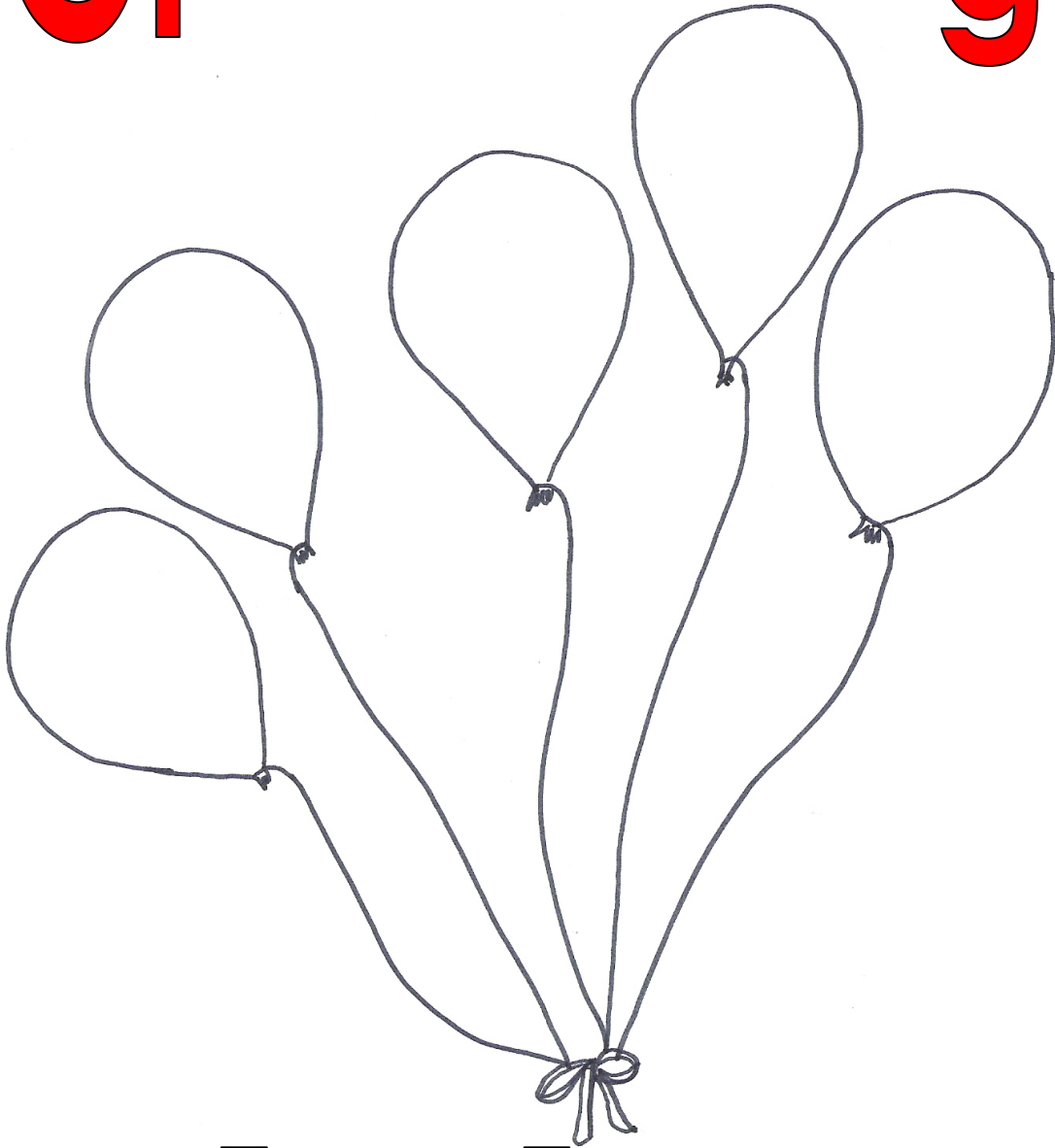

globos

Gl

gl

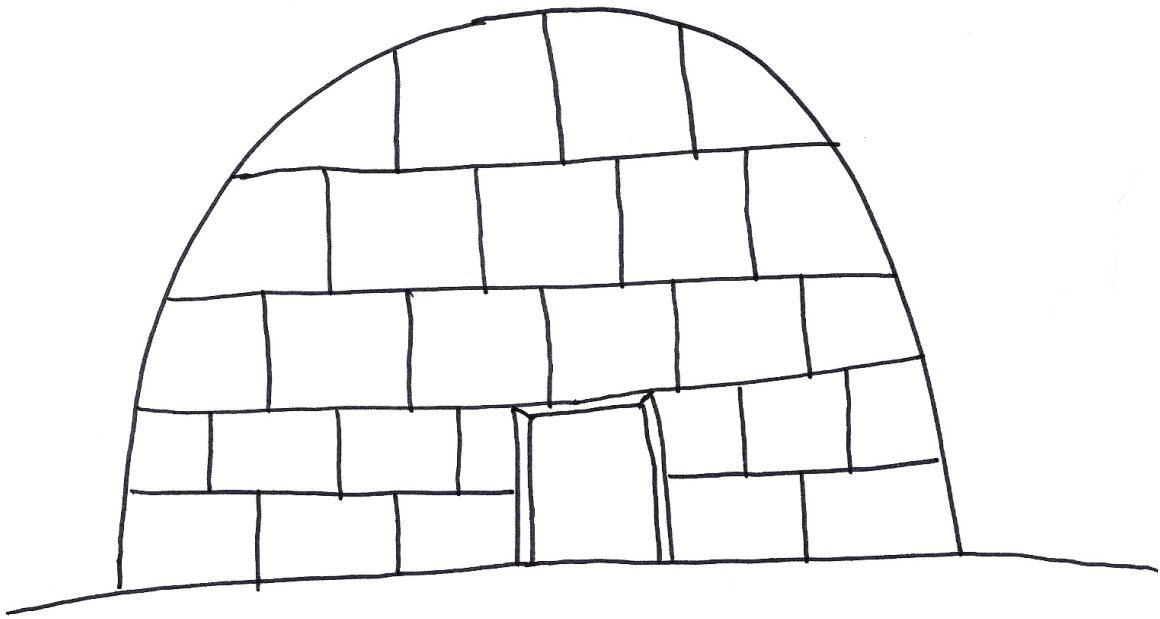

iglú

Gr

gr

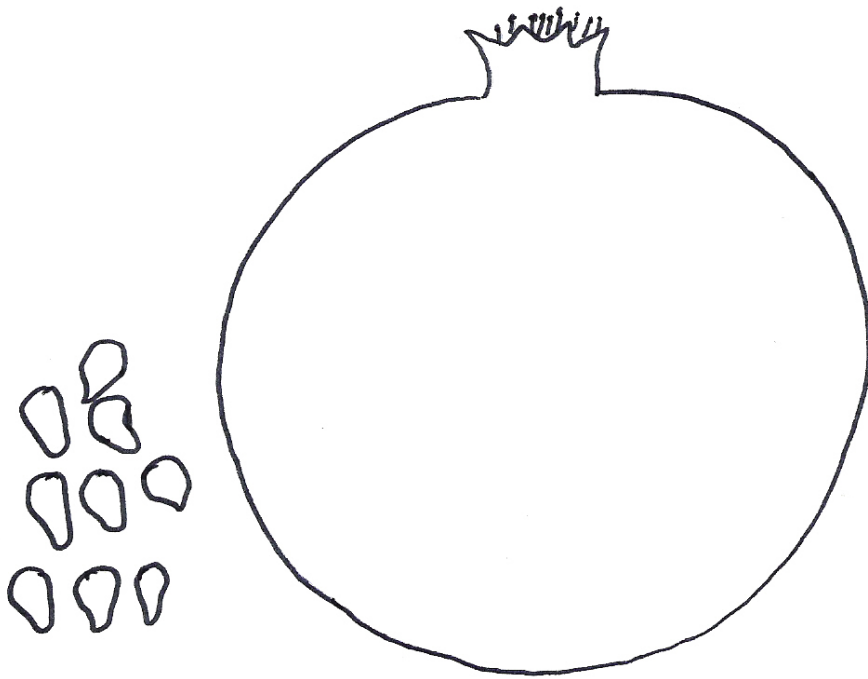

granada

Gr

gr



greñuda

Gr

gr

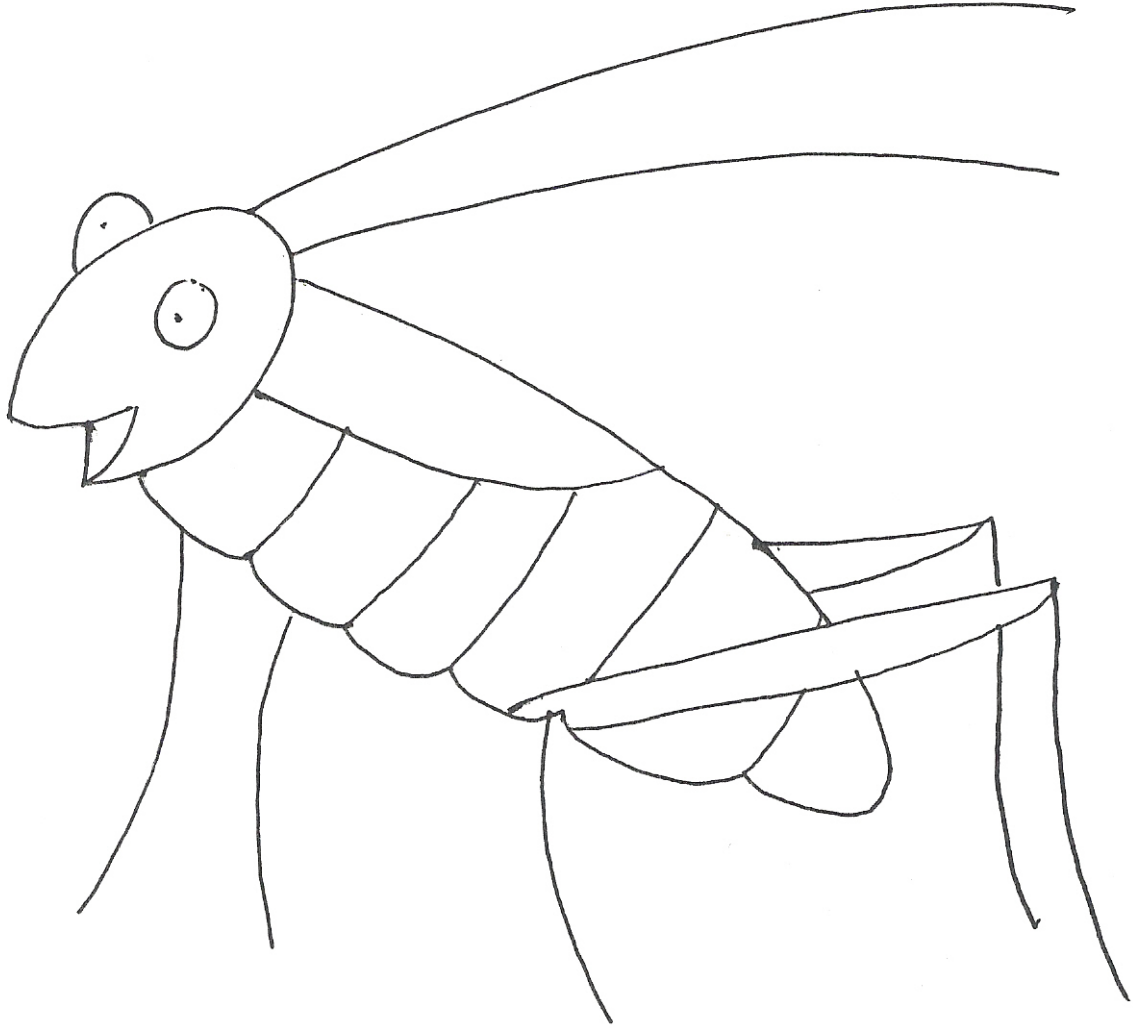

grillo

Gr

gr

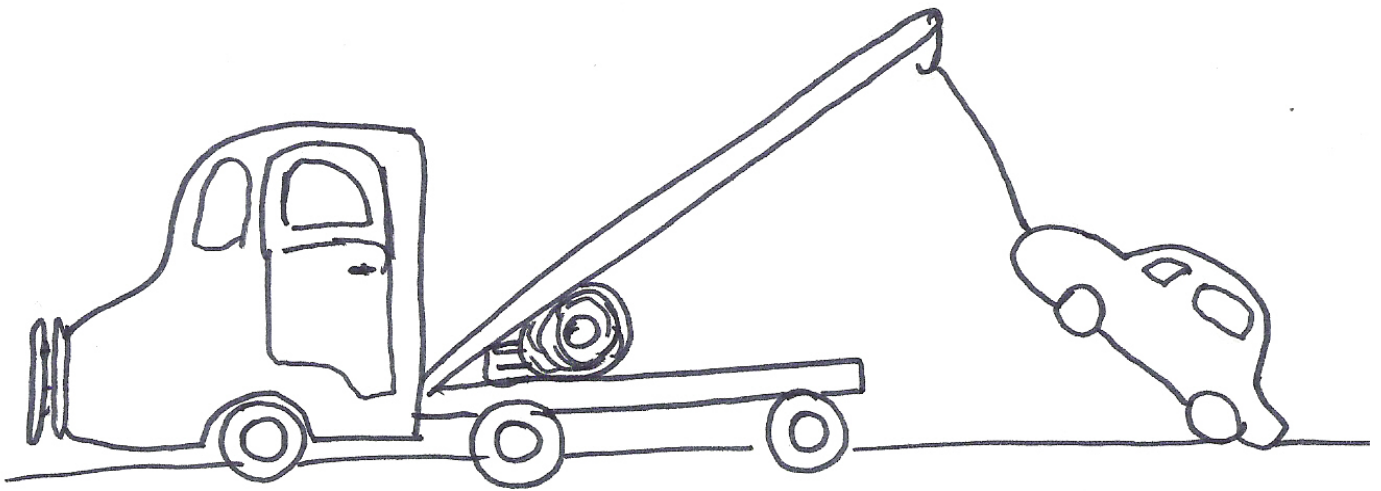

grúda

G

g



guitarra

H

h

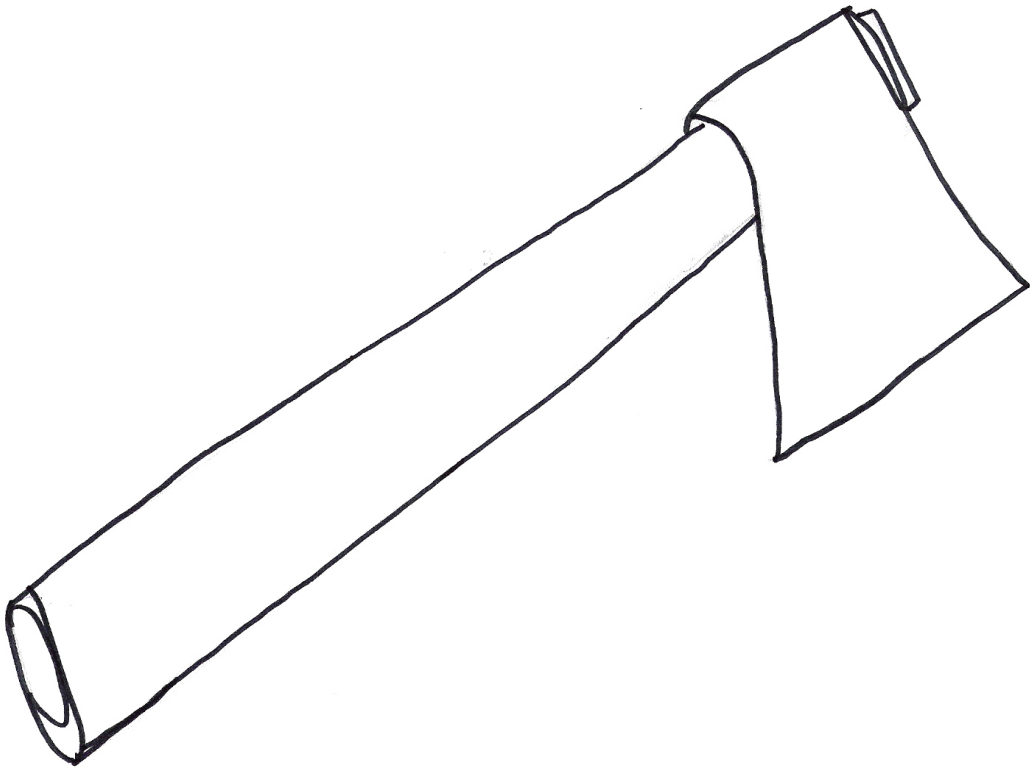

hacha

H

h

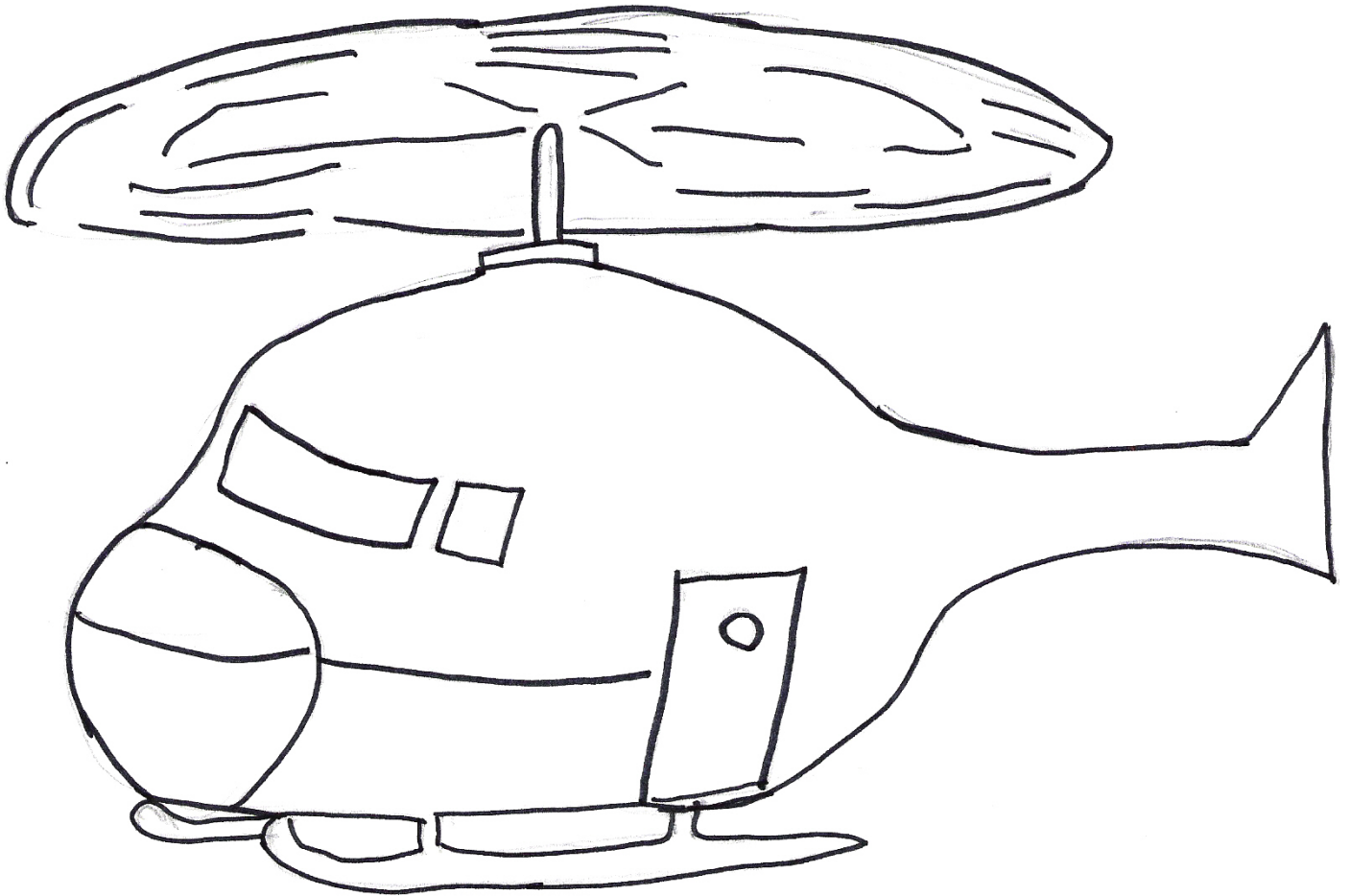

helicóptero

H

h

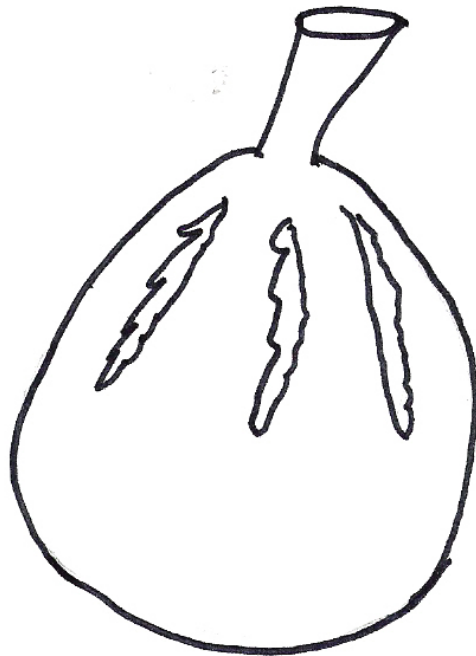

higo

H

h

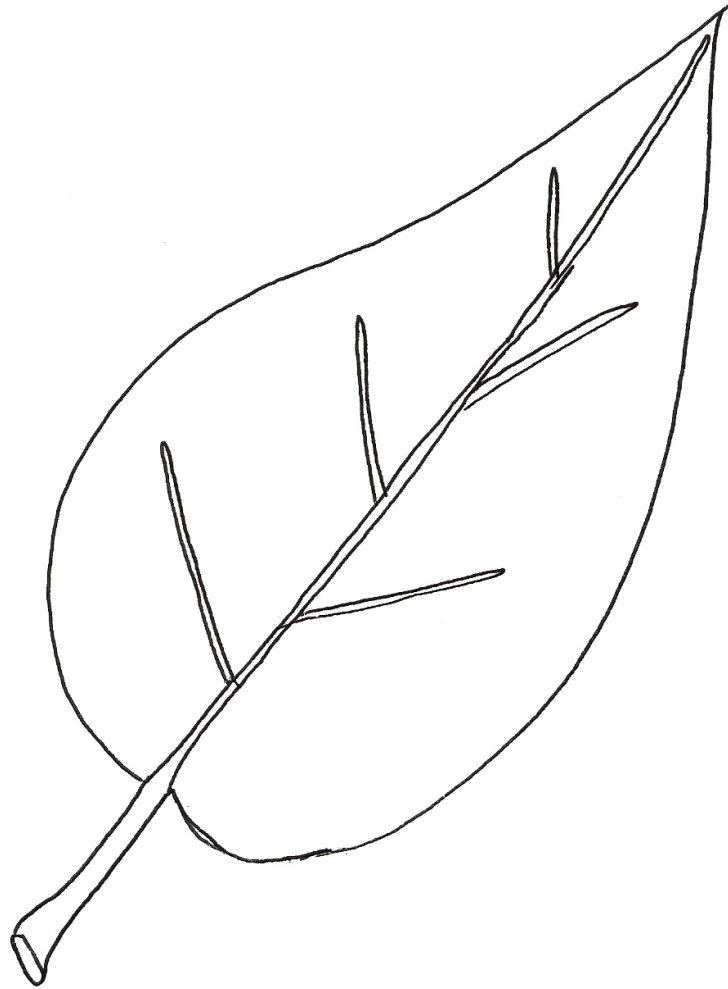

hojda

H

h

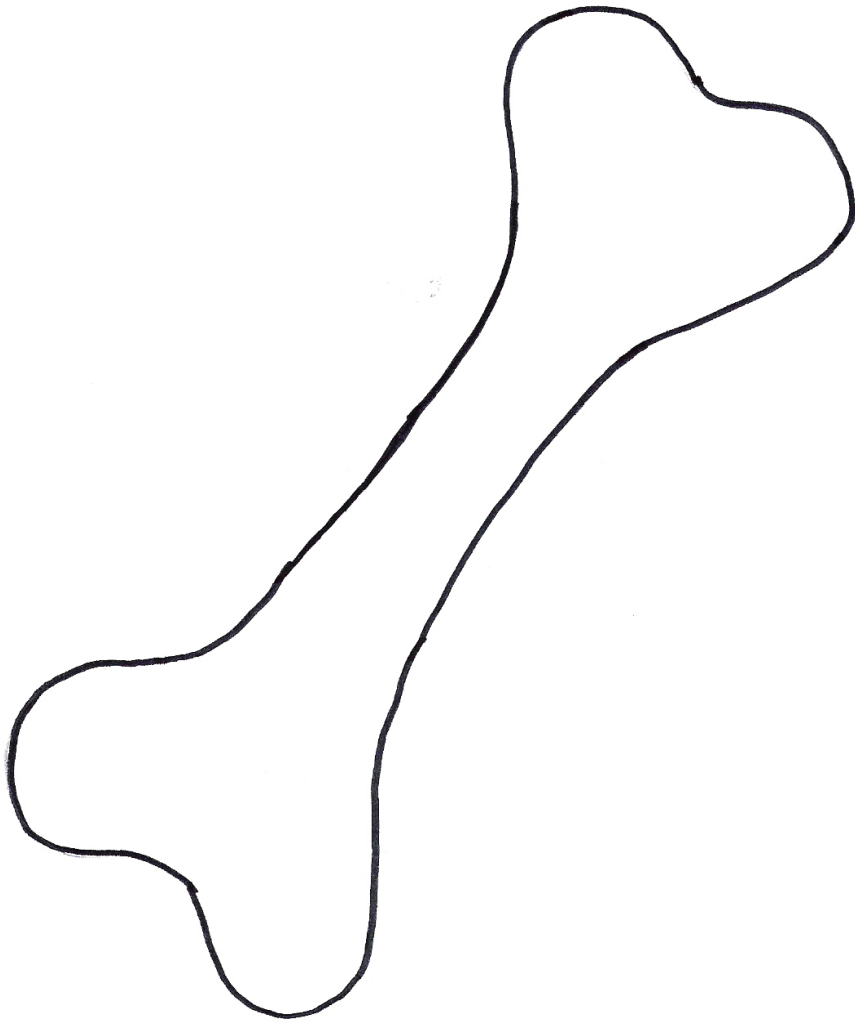

hueso

i

i

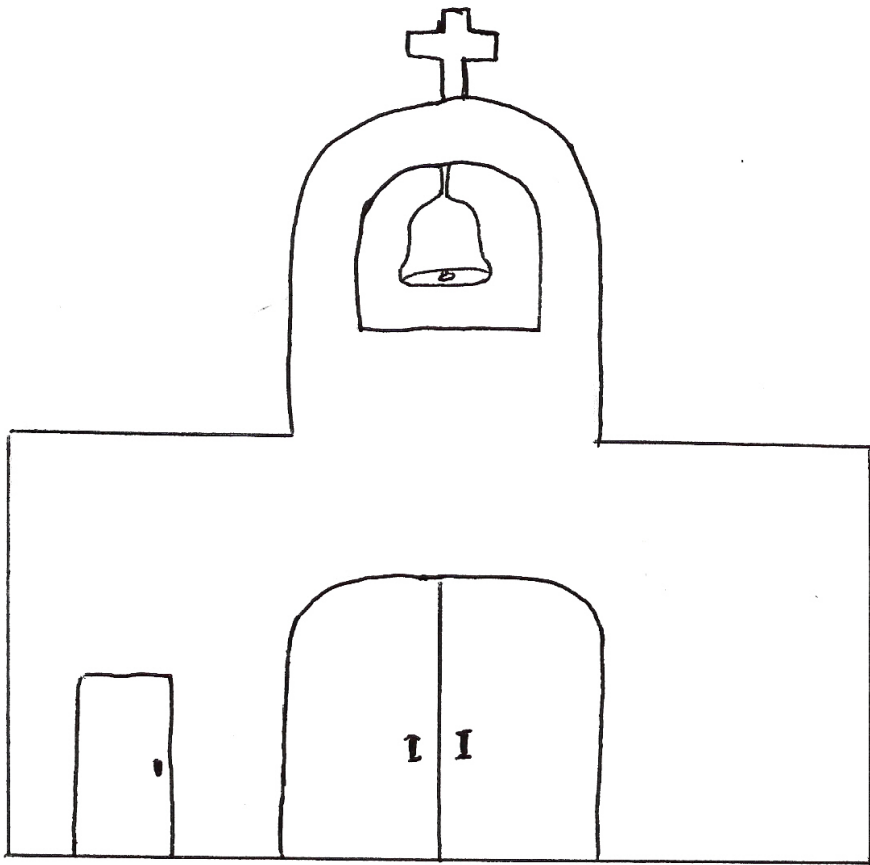

iglesia

J

j

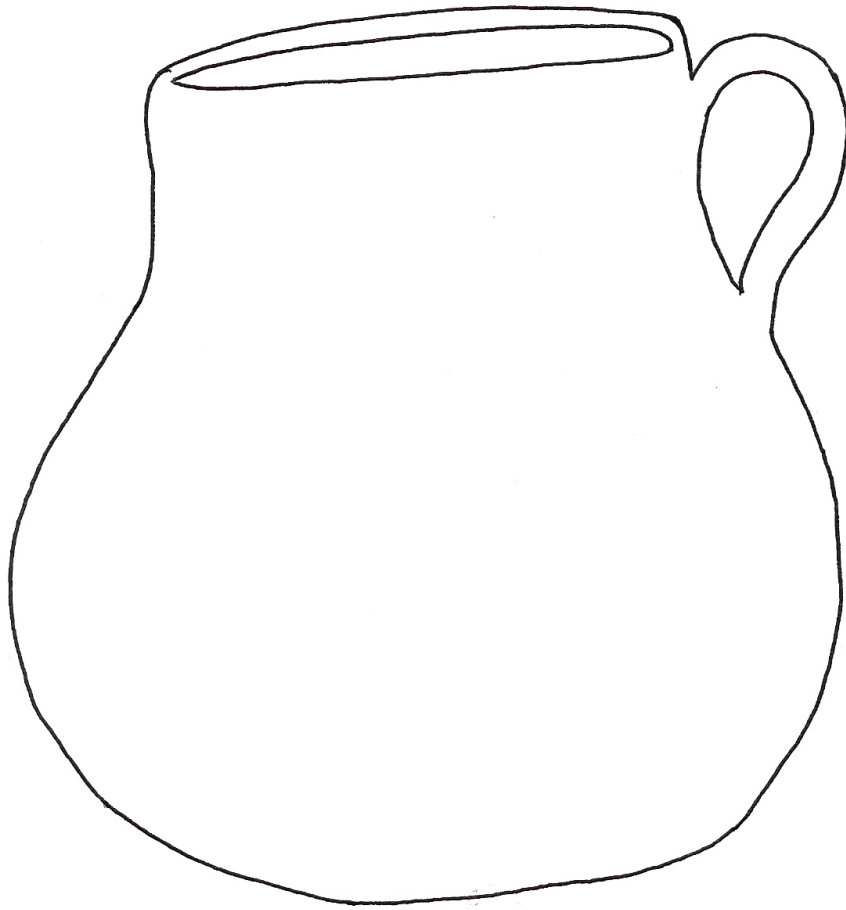

jarro

J

j

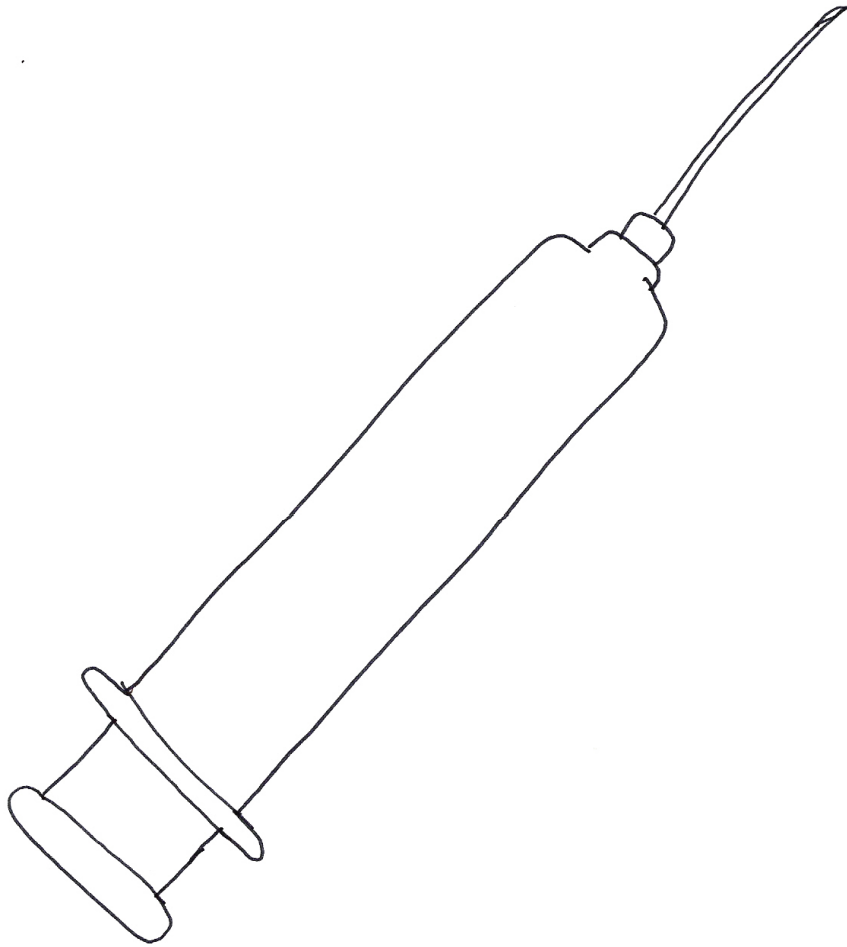

jeringa

J

j

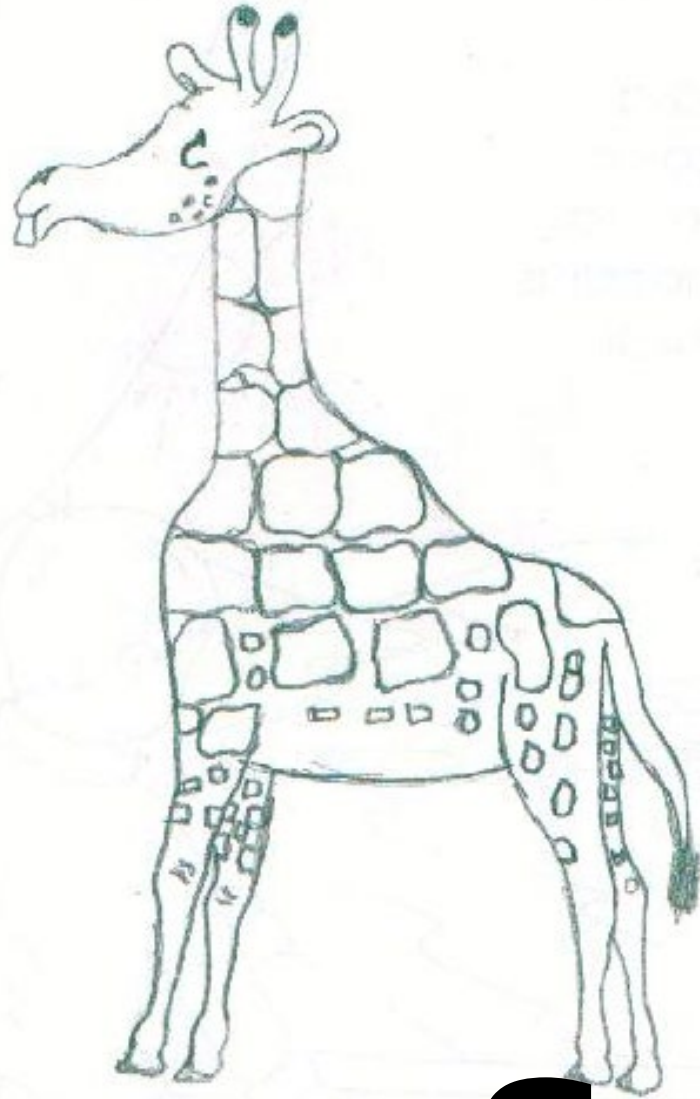

jirafa

J

j

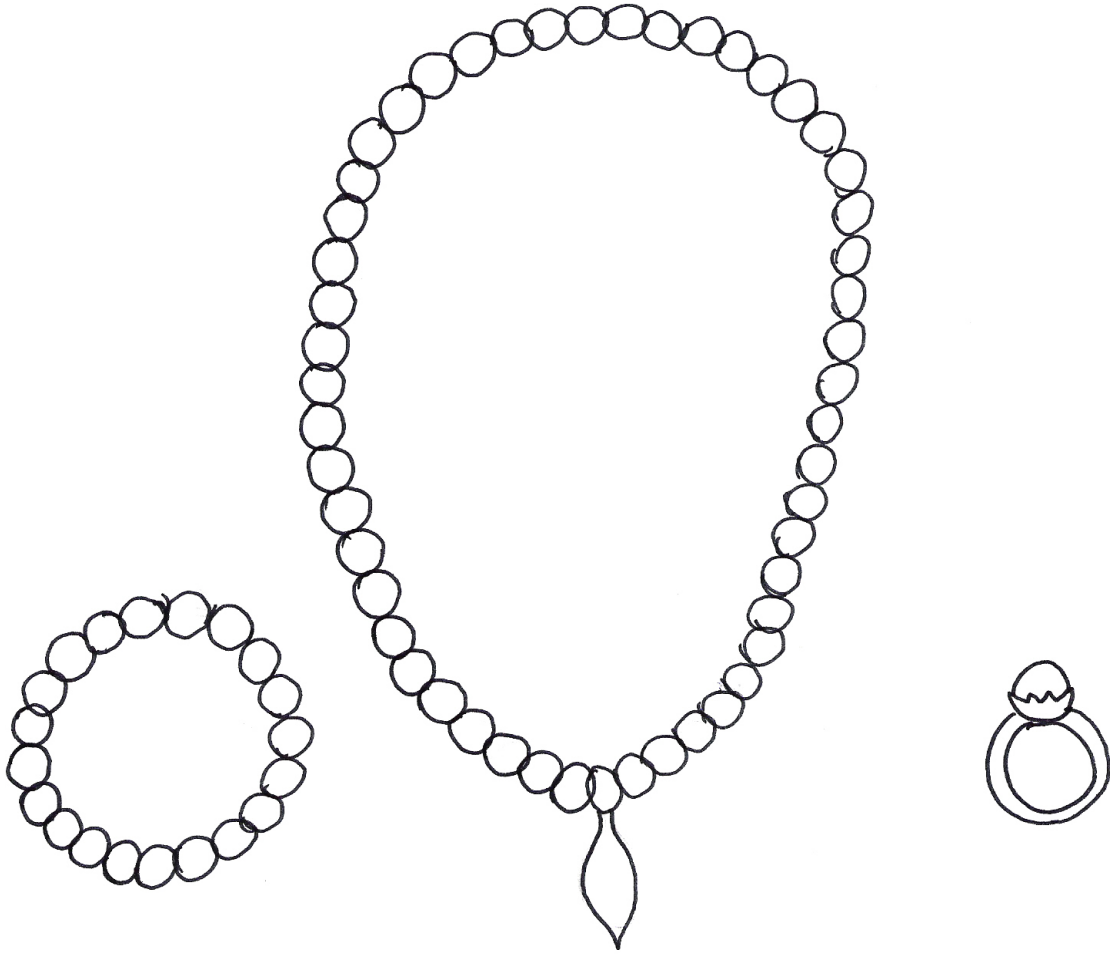

j joyas

J

j

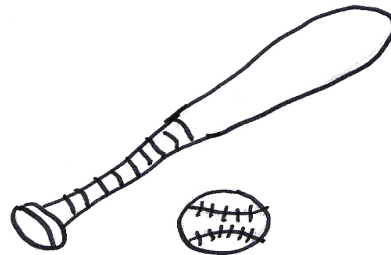
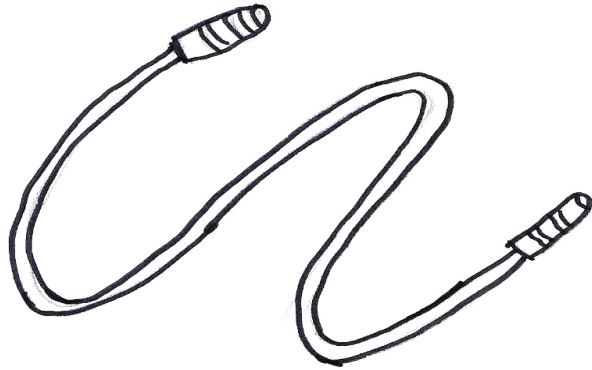
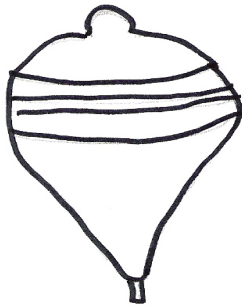

juguetes

K

k

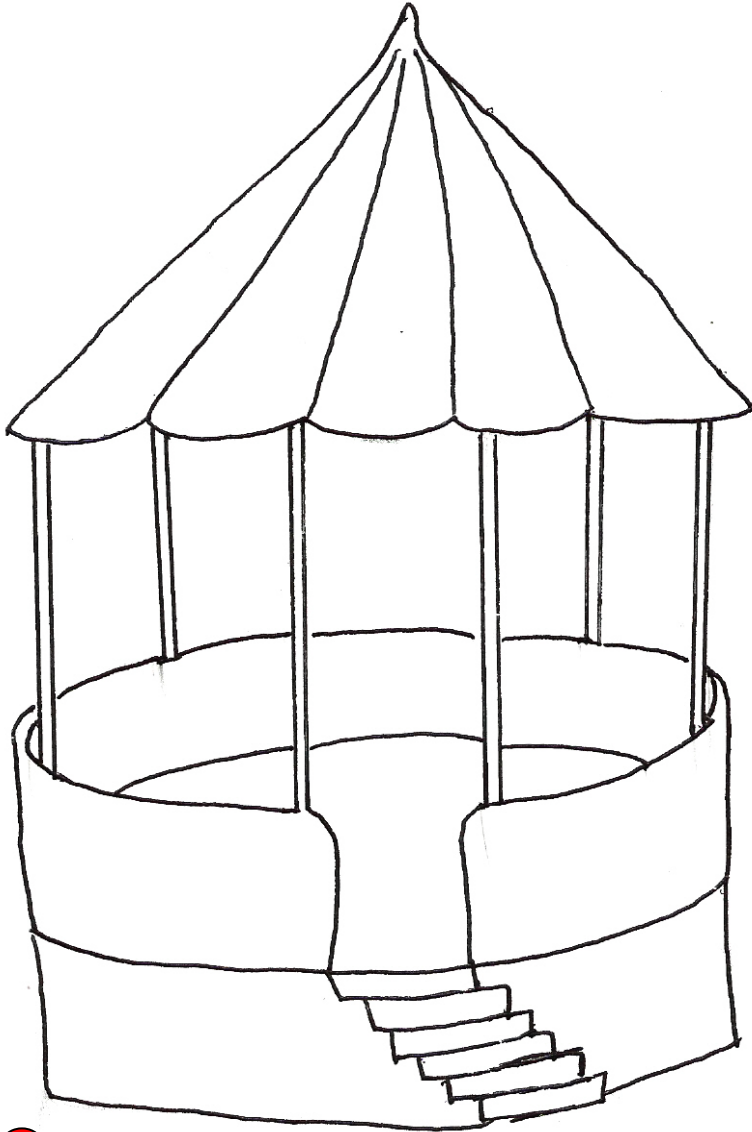

kiosco

L

l

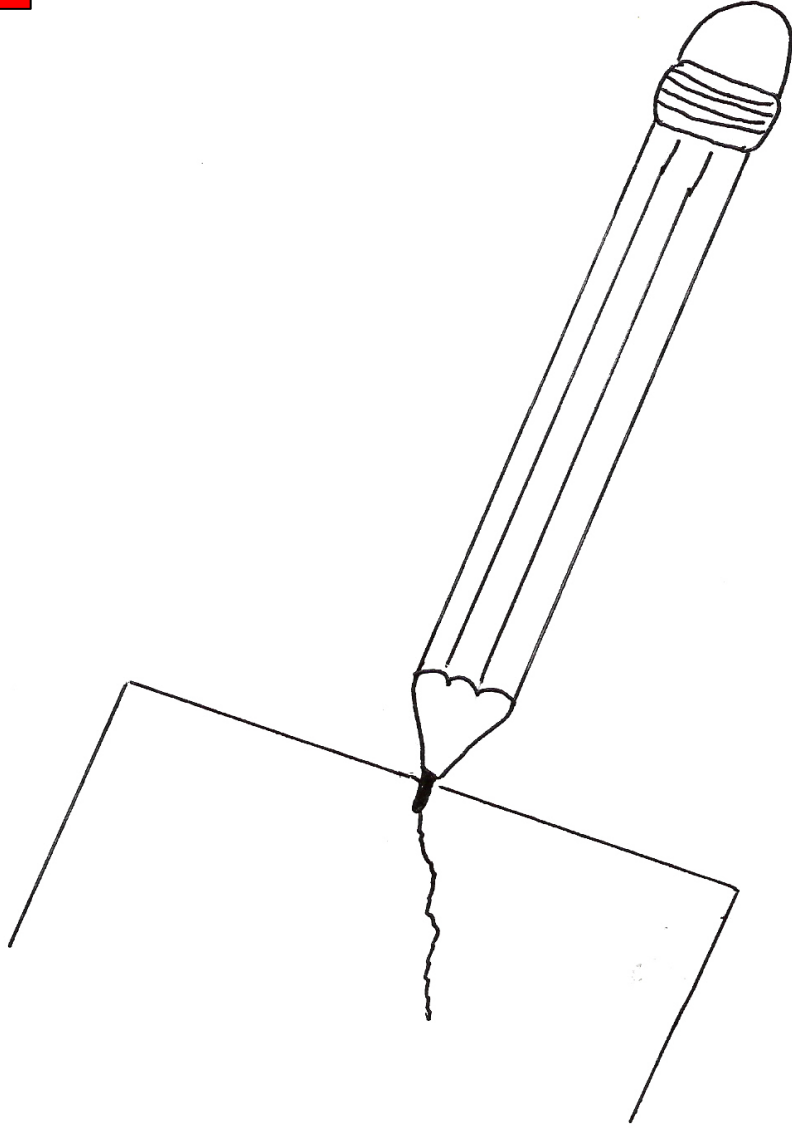

lápiz

L

I

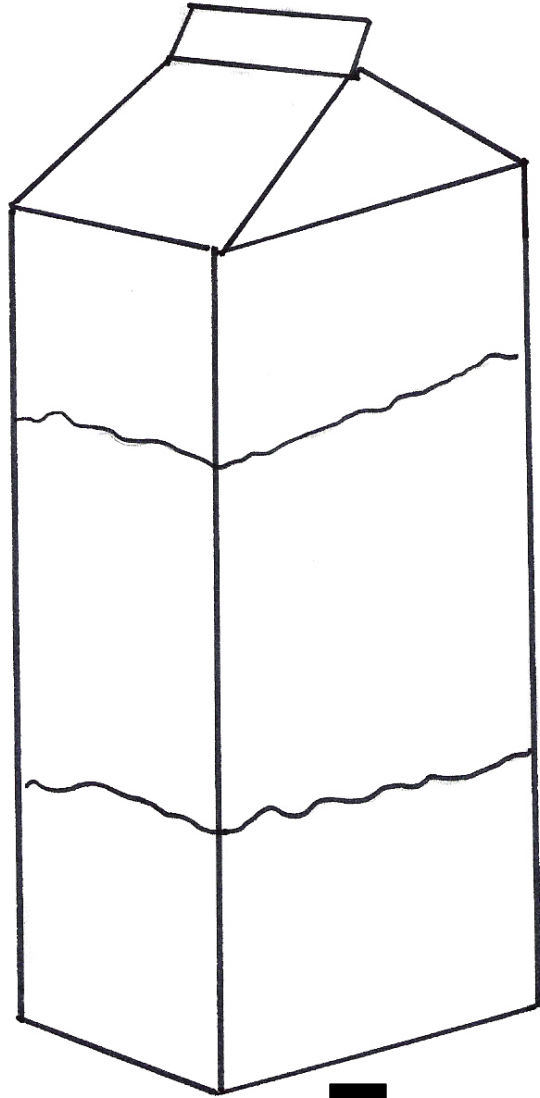

leche

L

I

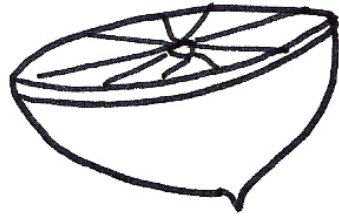
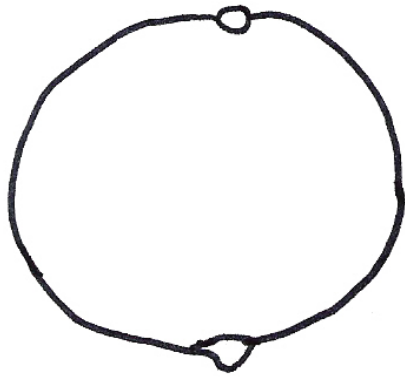

limón

L

l

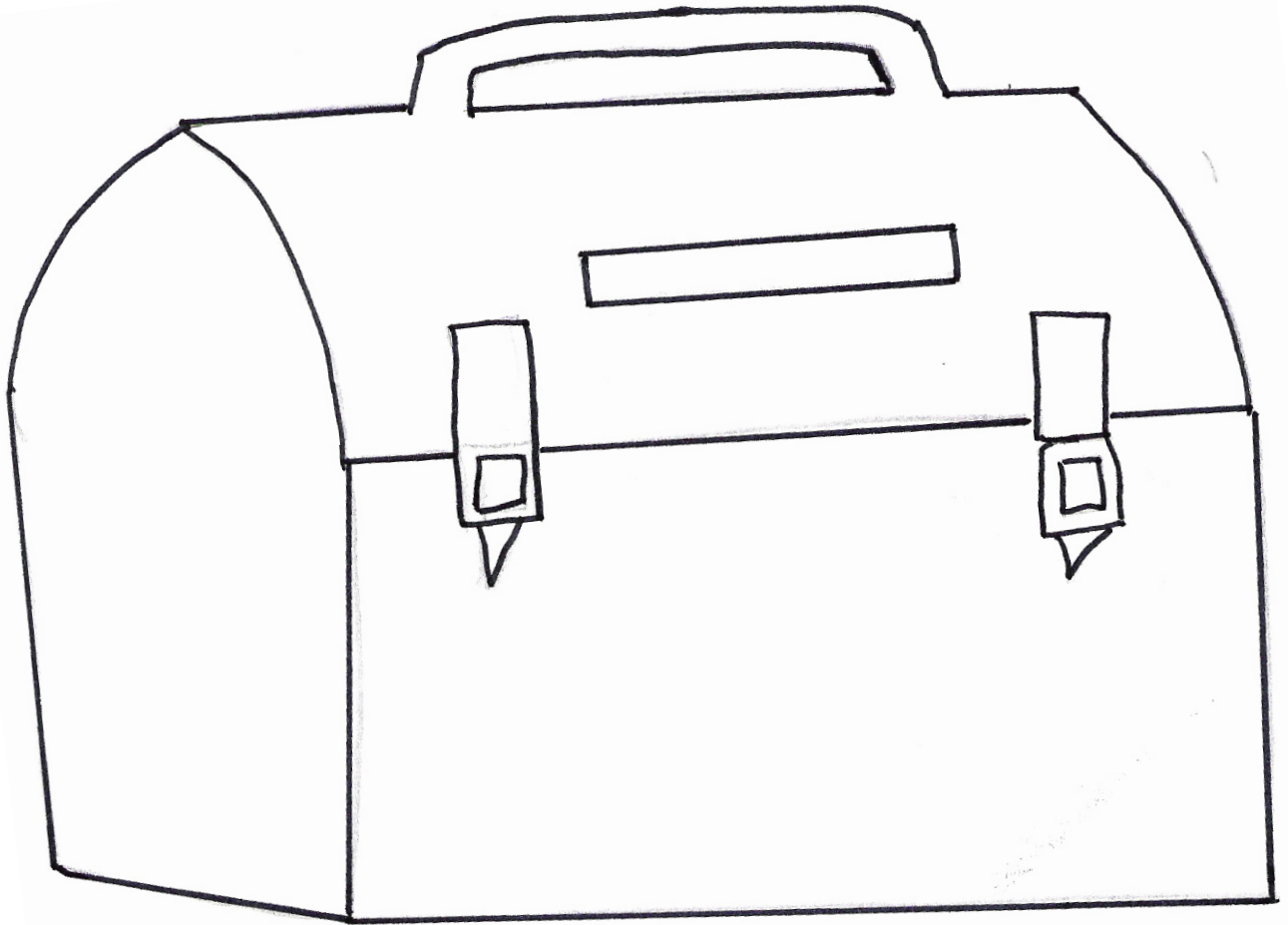

lonchera

L



luna

LI

II

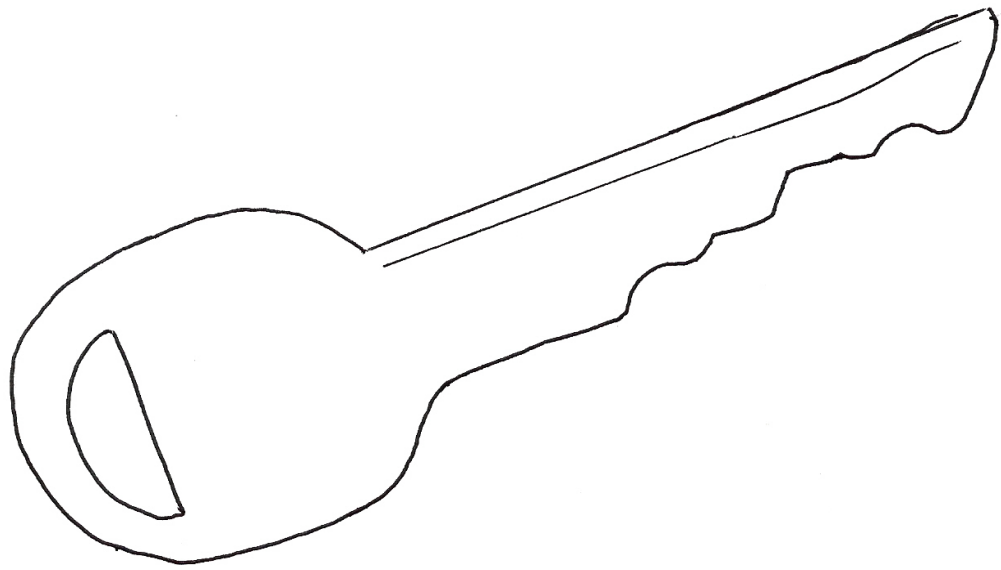

II have

LI

II

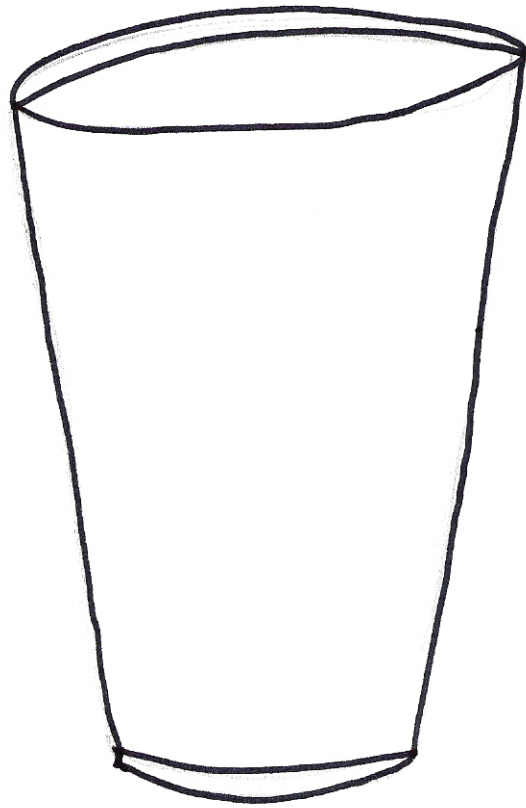

II **e**no

LI

||

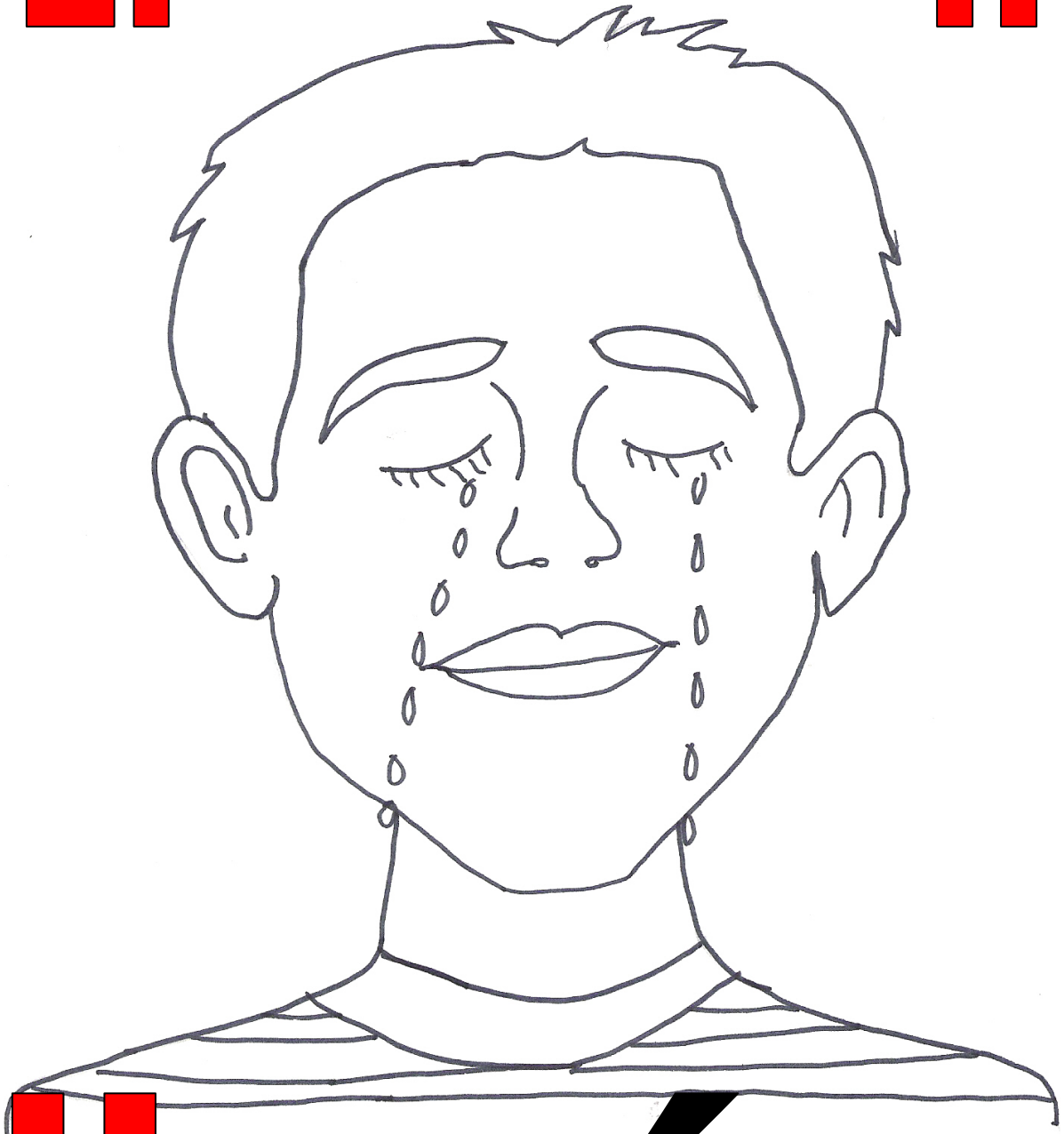

||lorón

LI

II

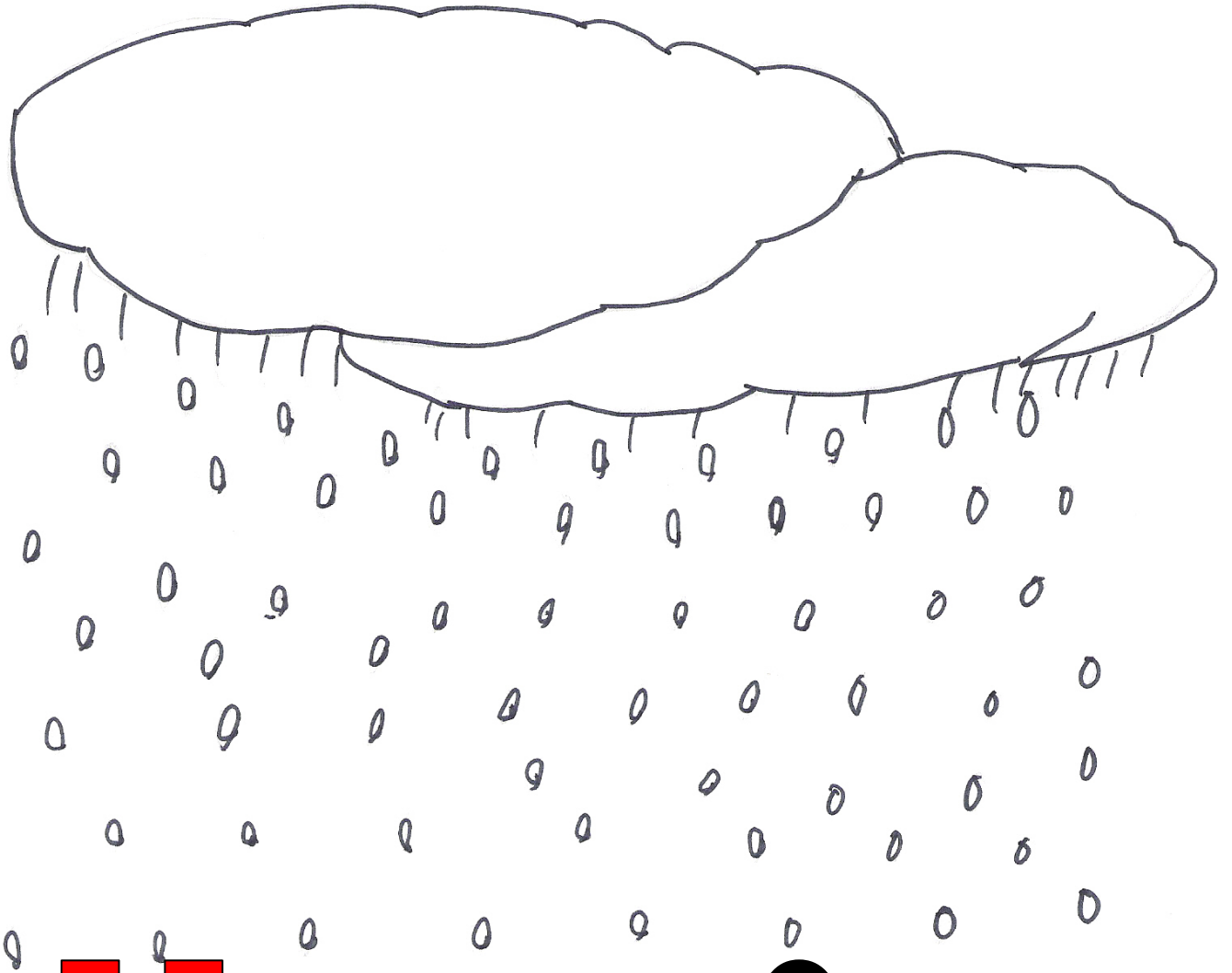

lluvia

M

m

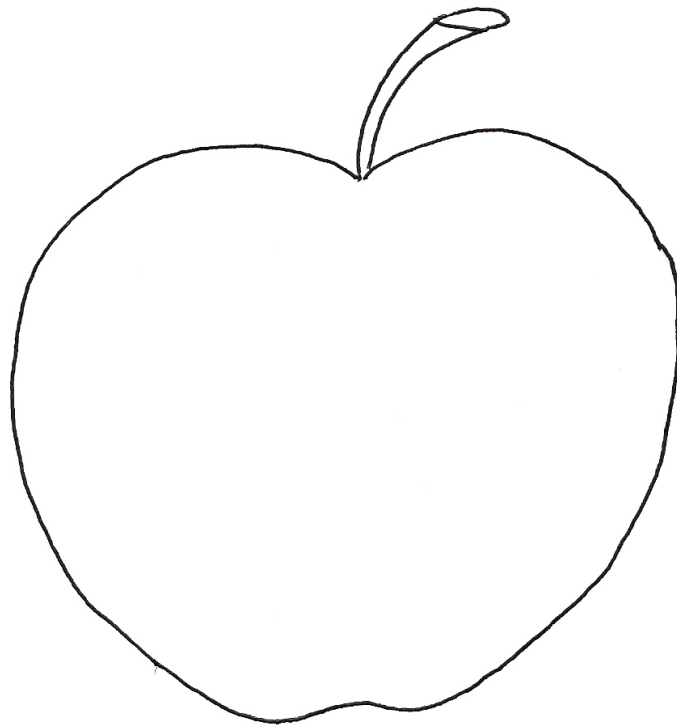

manzana

M

m

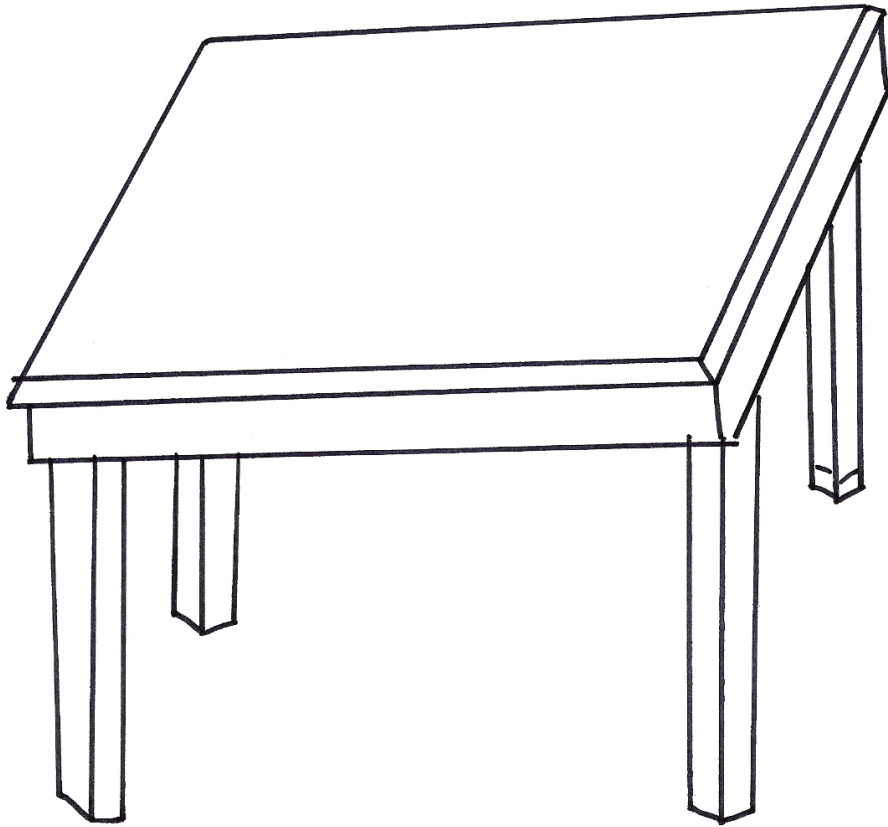

mesa

M

m

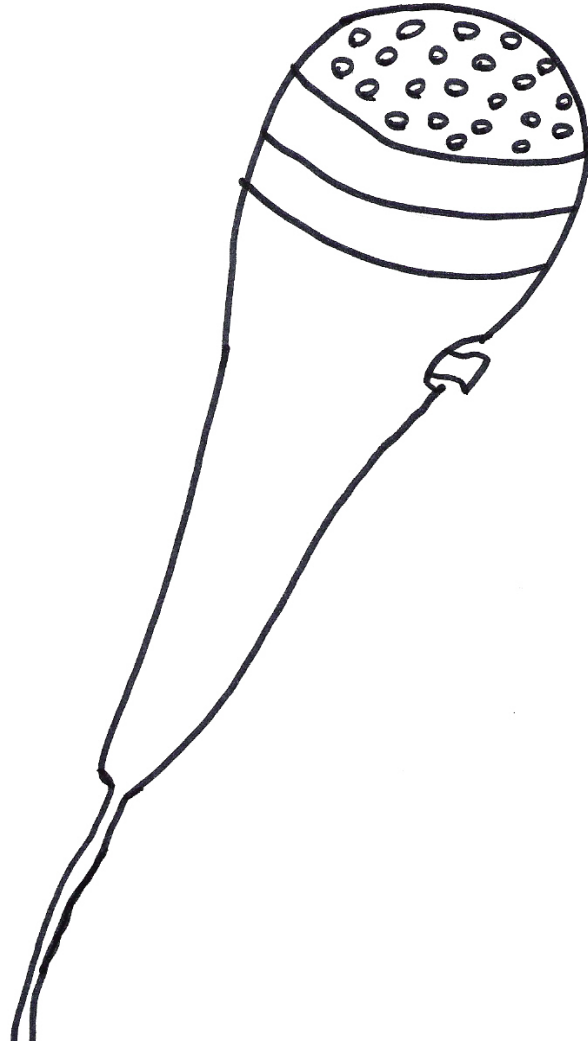

mi crófono

M

m

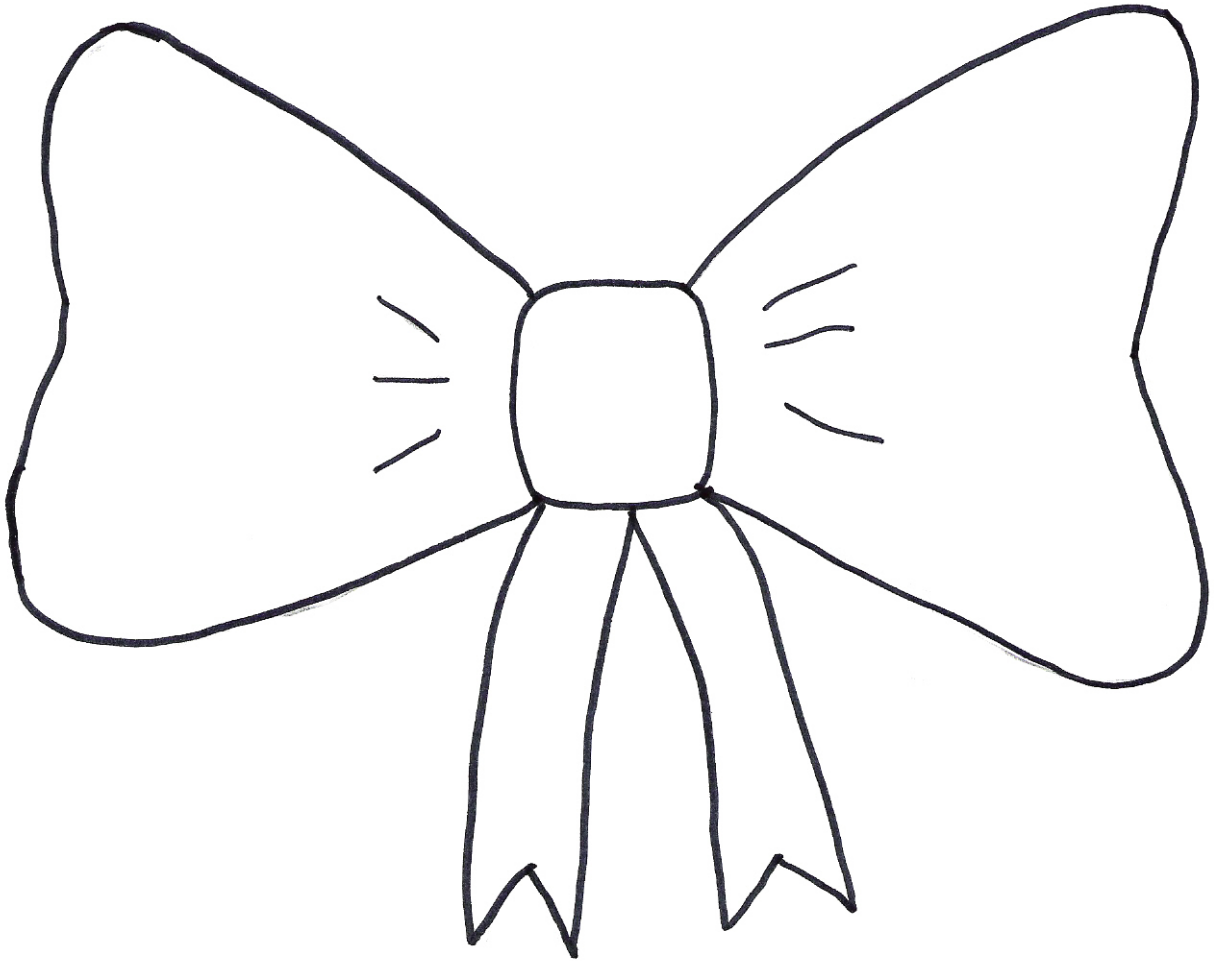

moño

M

m

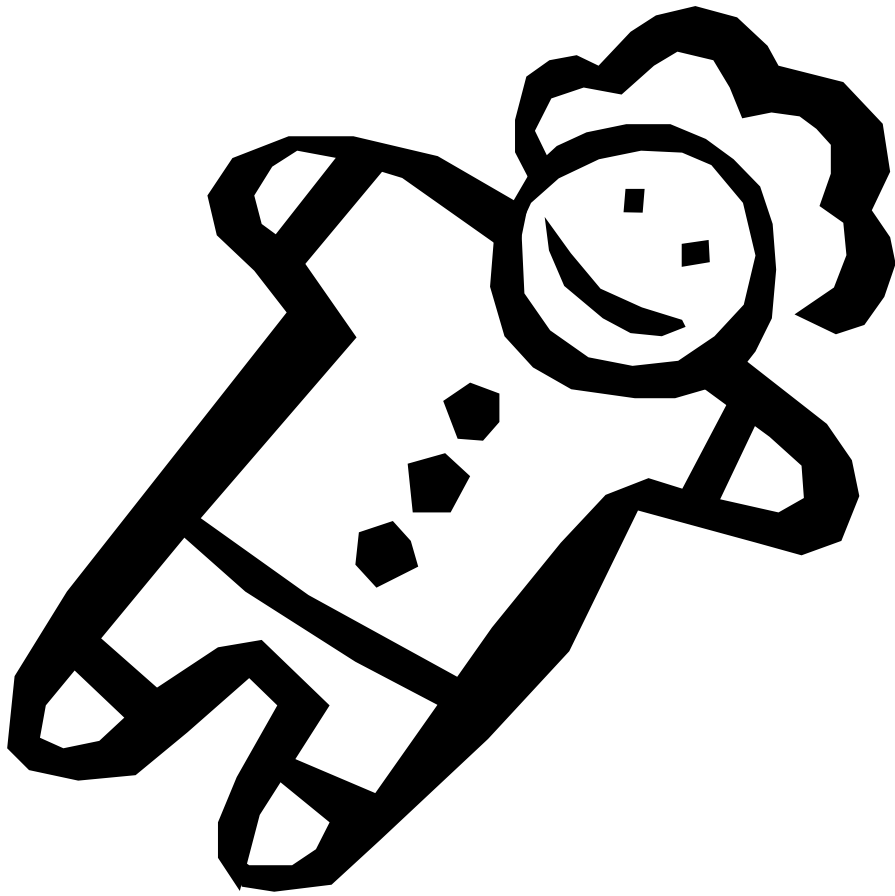

můňeca

N

n

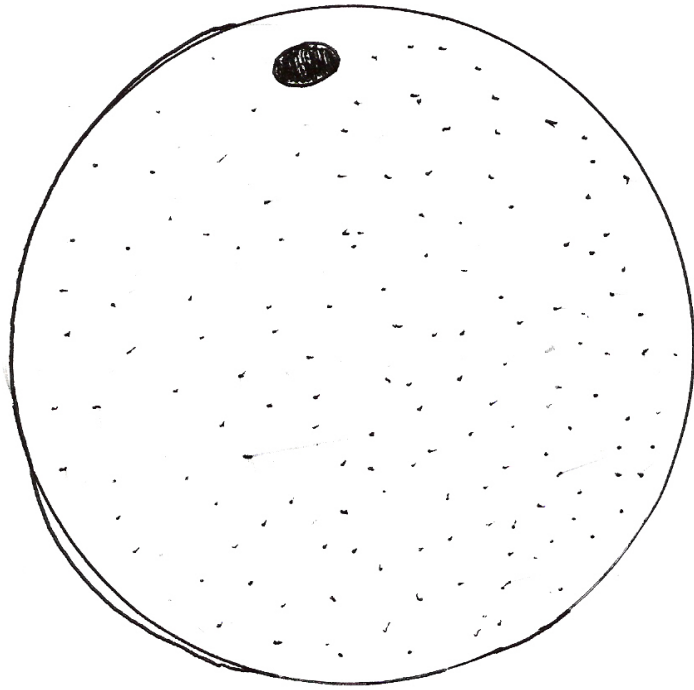

naranja

N

n



negro

N

n



nido

N

n

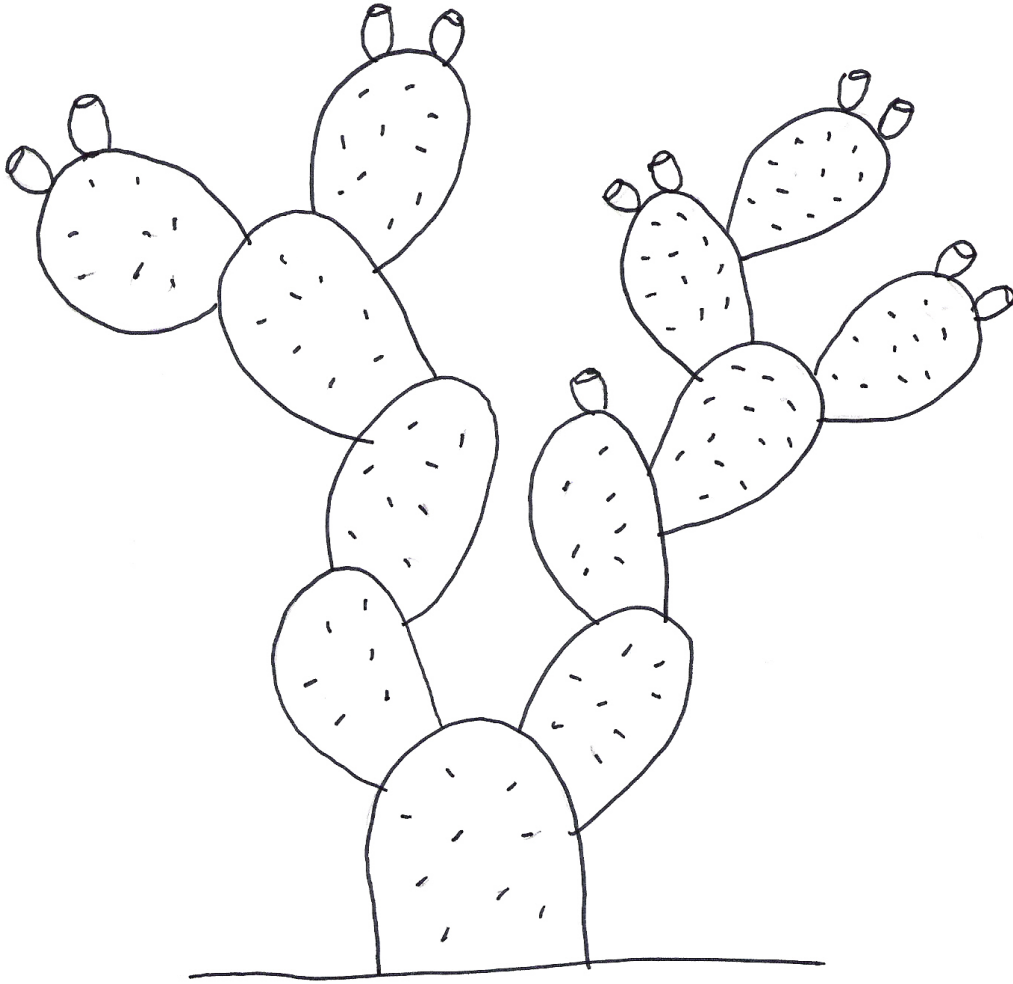

nopal

N

n

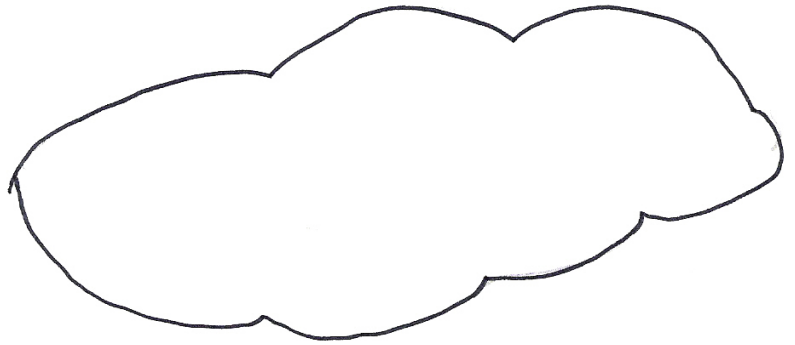
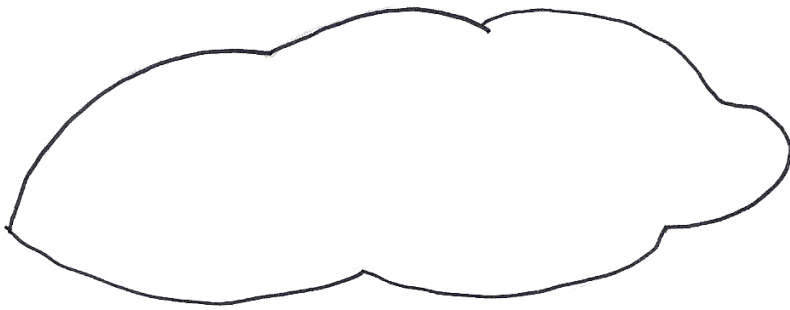

n **u** **b** **e**

Ñ

ñ



Enciclopedia Encarta, Dorling
Kindersley

ñandú

Ñ

ñ

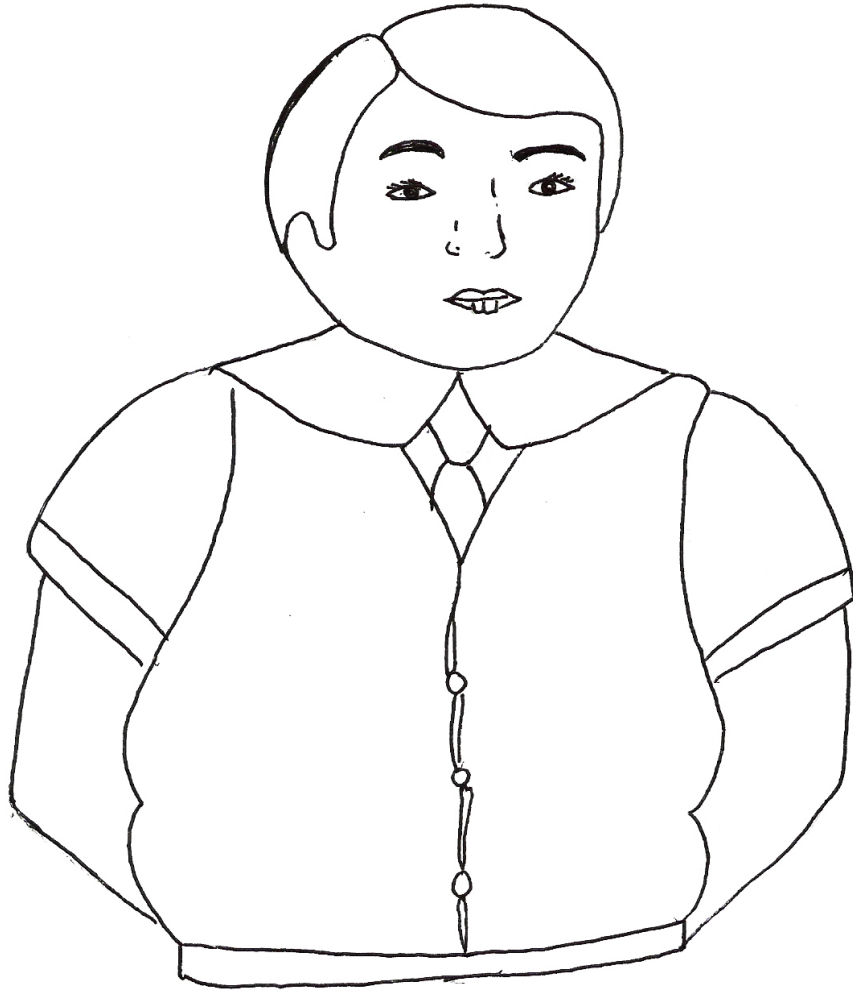

ño ño

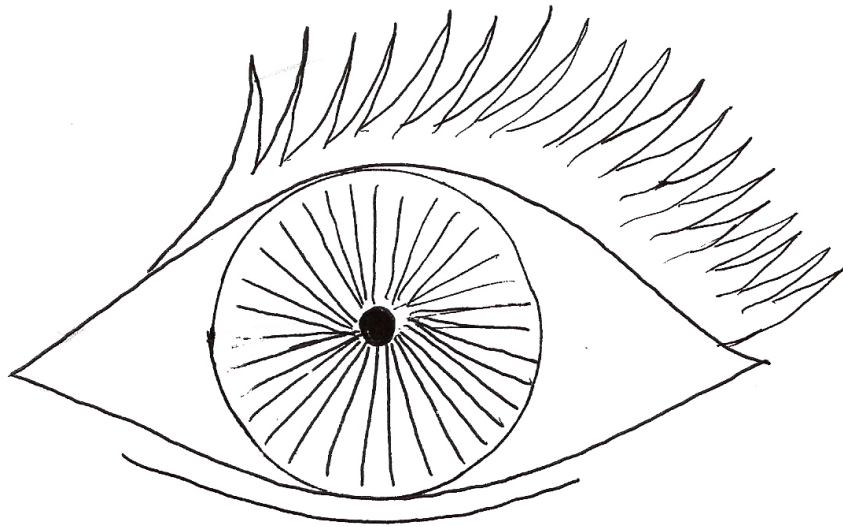
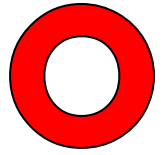
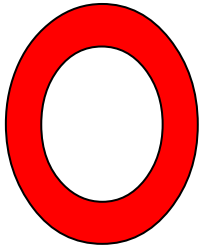

ojo

P

p

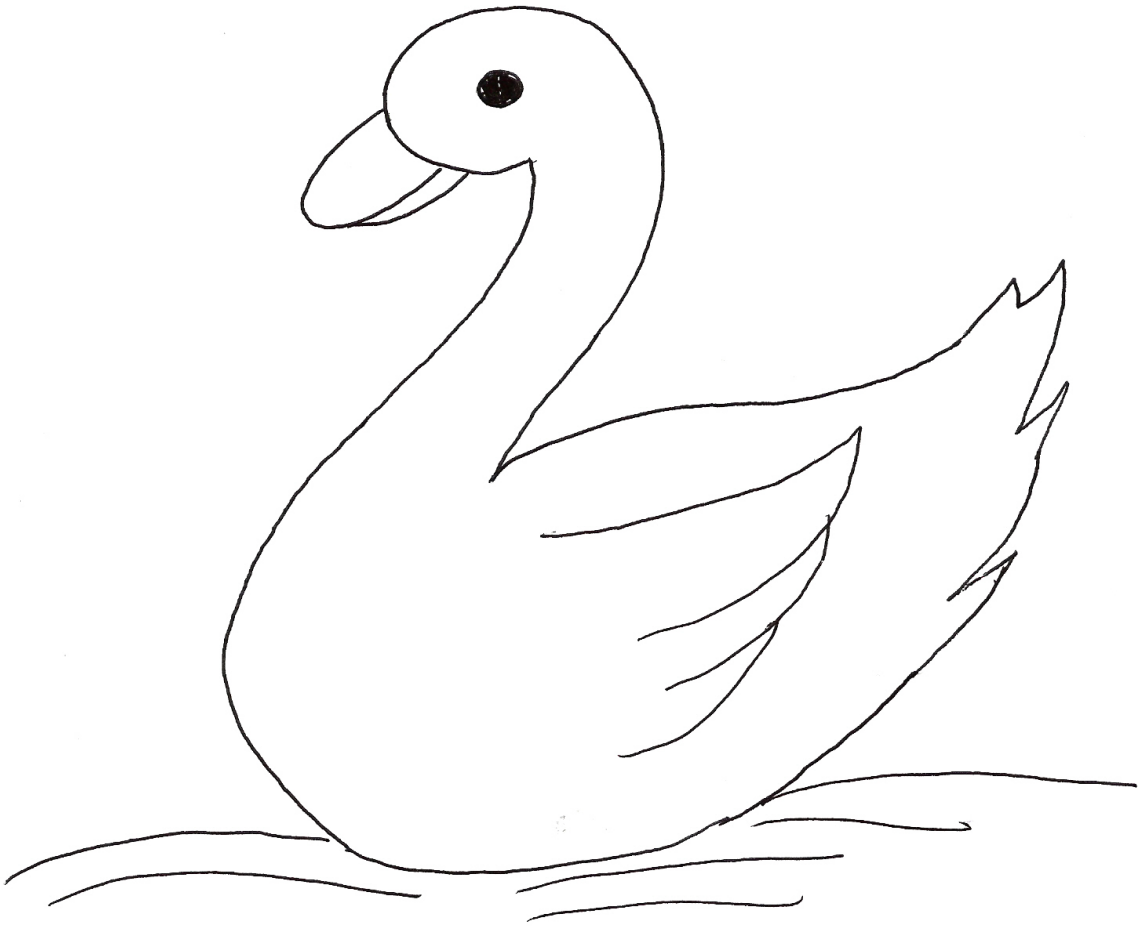

pato

P

p

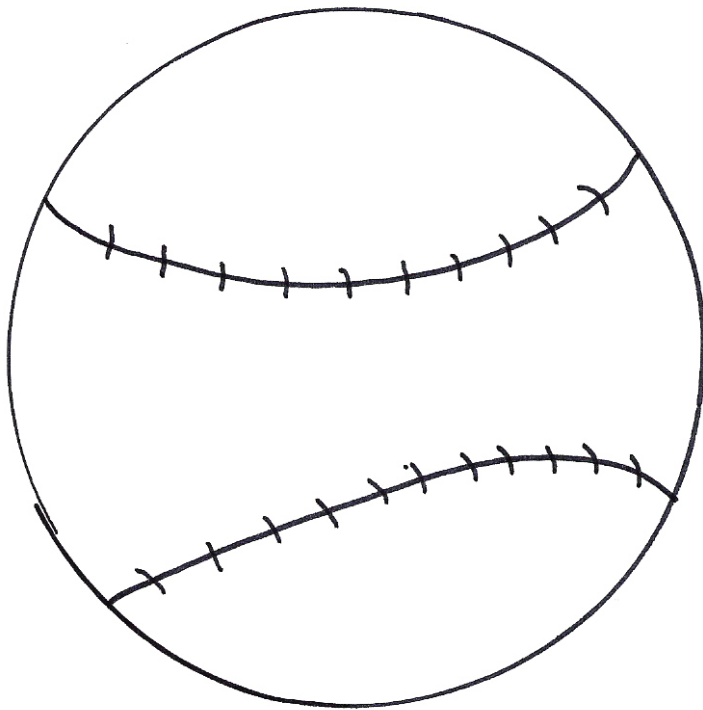

p pelota

P

p

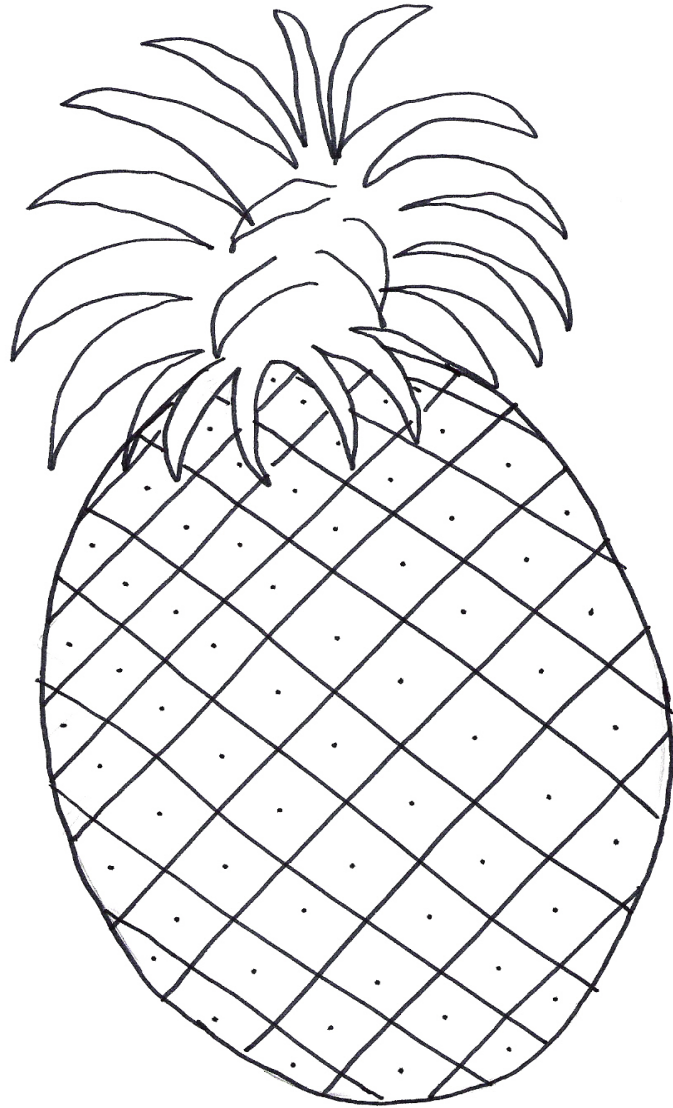

piñã

P

p



pollito

P

p

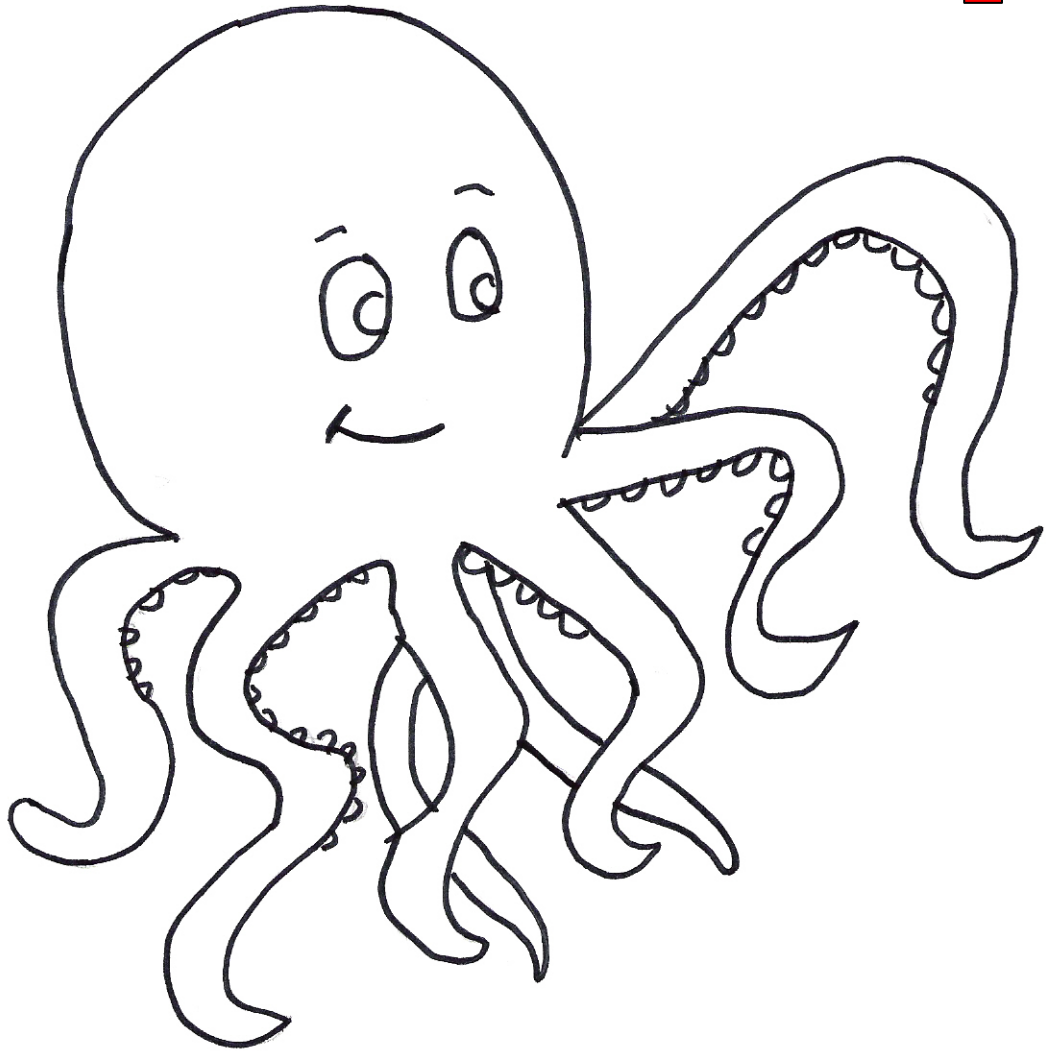

pulpito

PI

pl

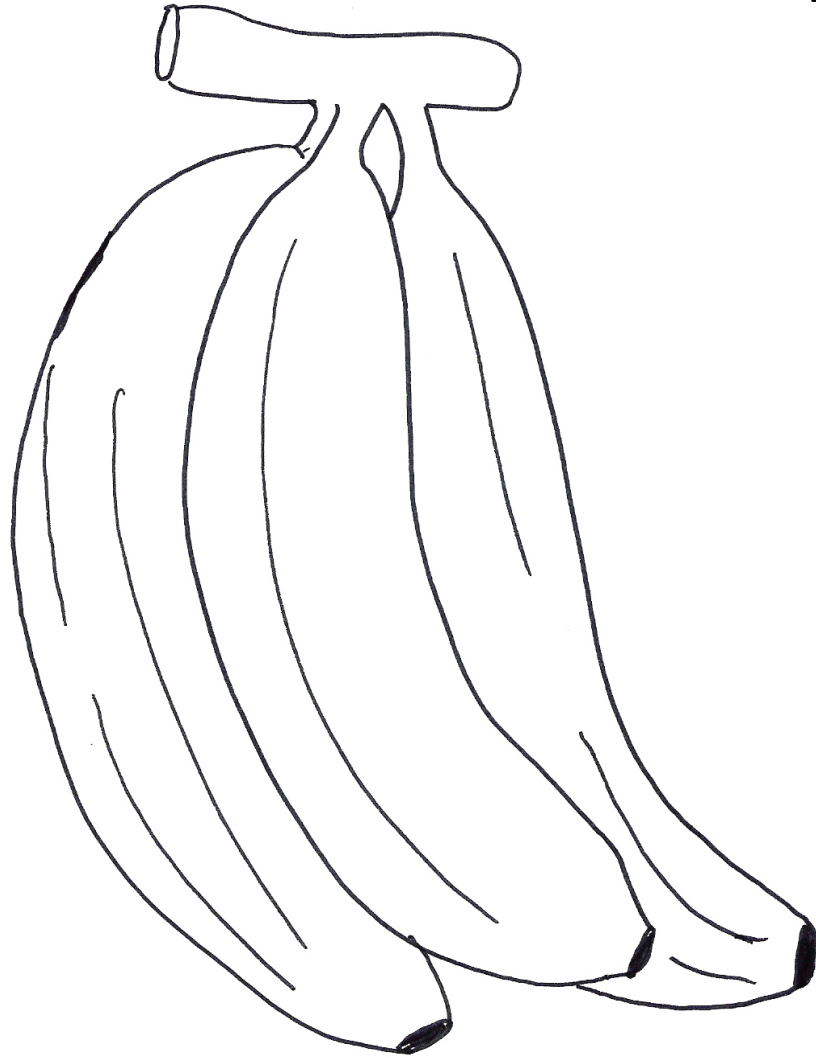

platano

PI

pi



pleito

PI

pl

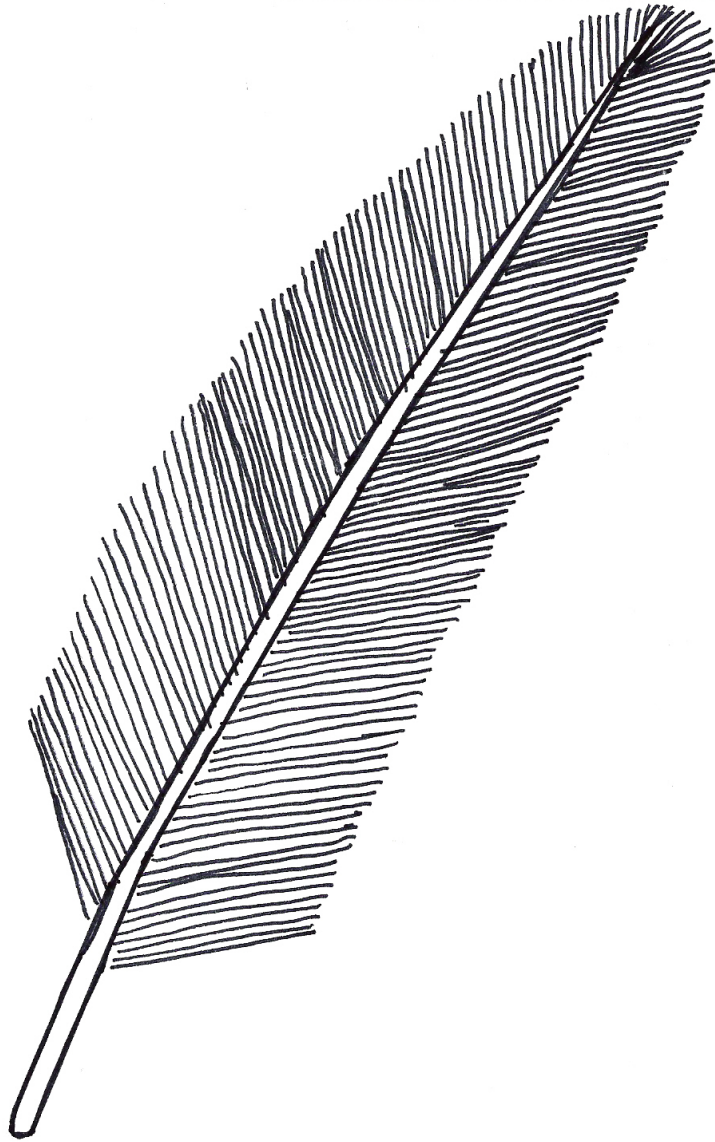

pluma

Pr

pr



premio

Pr

pr

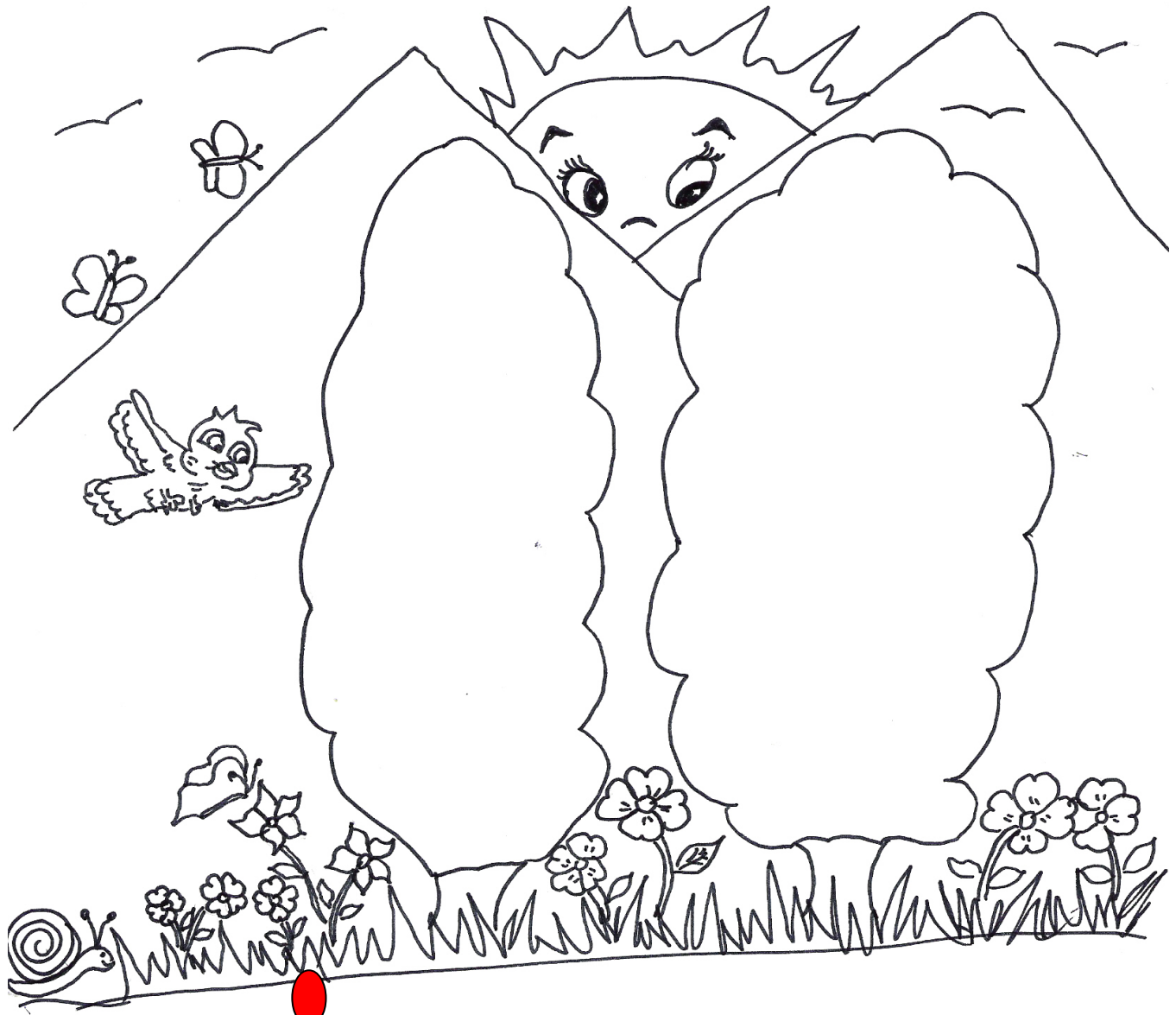



primavera

Pr

pr

Nombre: _____

1. Escribe el nombre a cada dibujo

		
_____	_____	_____

2. Dibuja los objetos que se te piden

4	10	8
---	----	---

prueba

Q

q

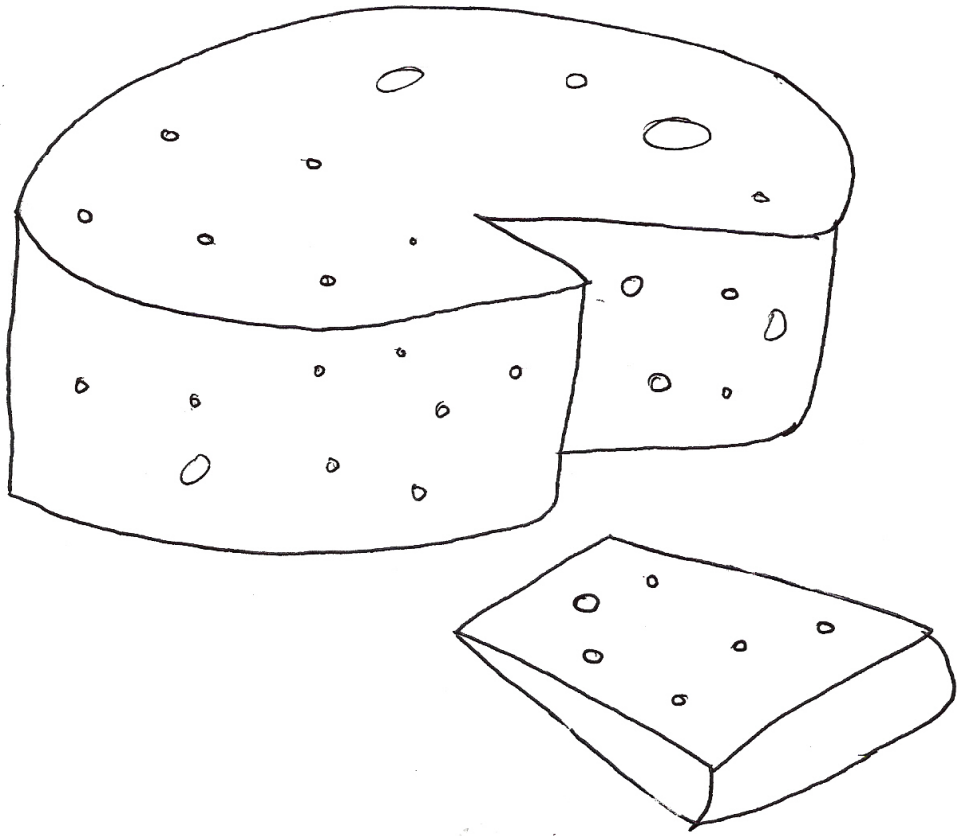

queso

Q

q

15

quin

R

r

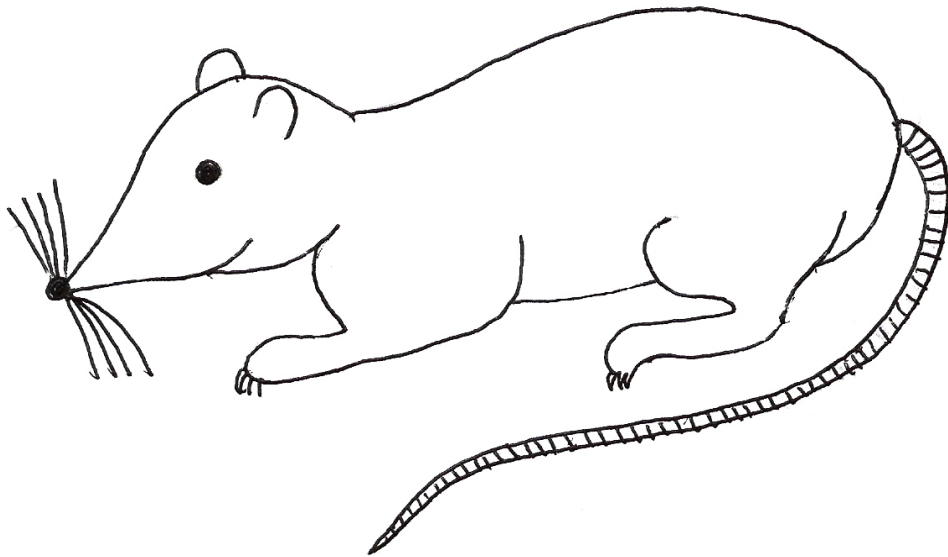

rata

R

r

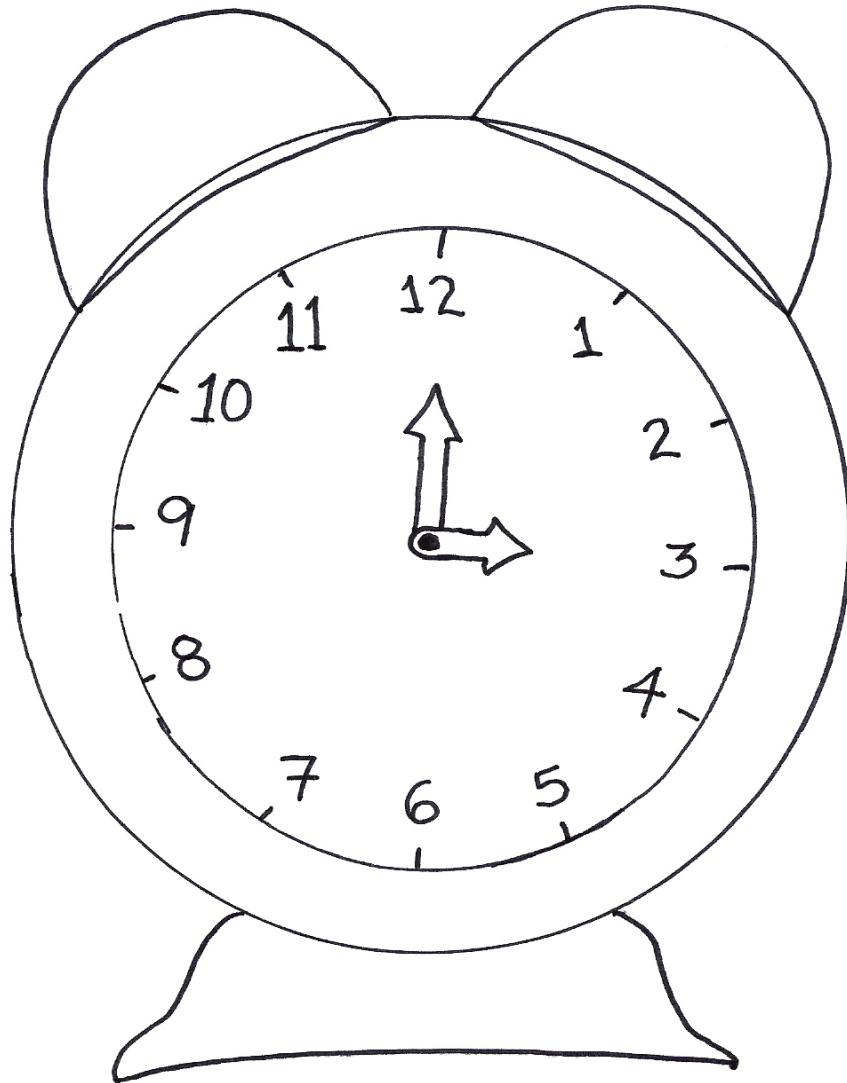

r **reloj**

R

r

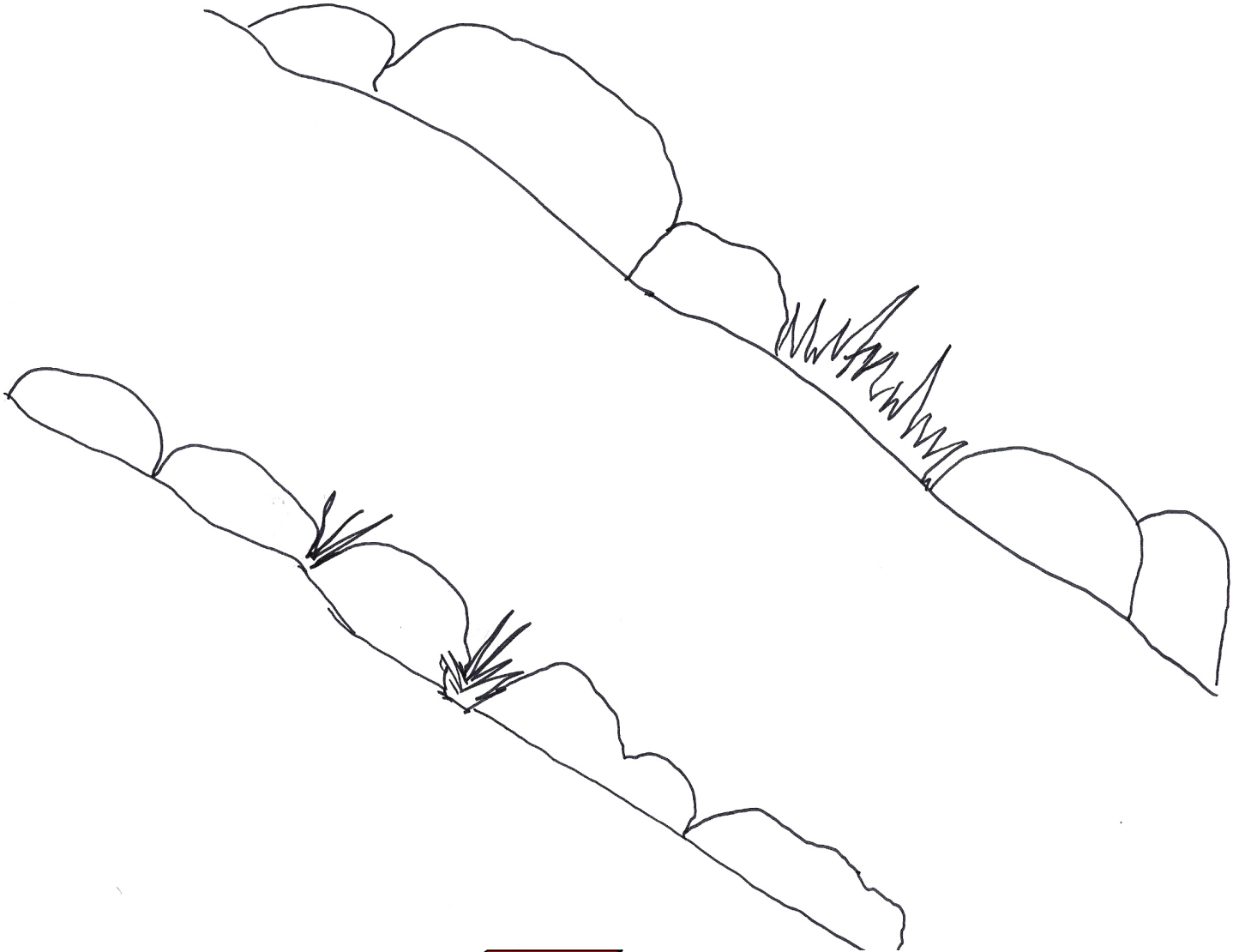

río

R

r



ro**s**a

R

r

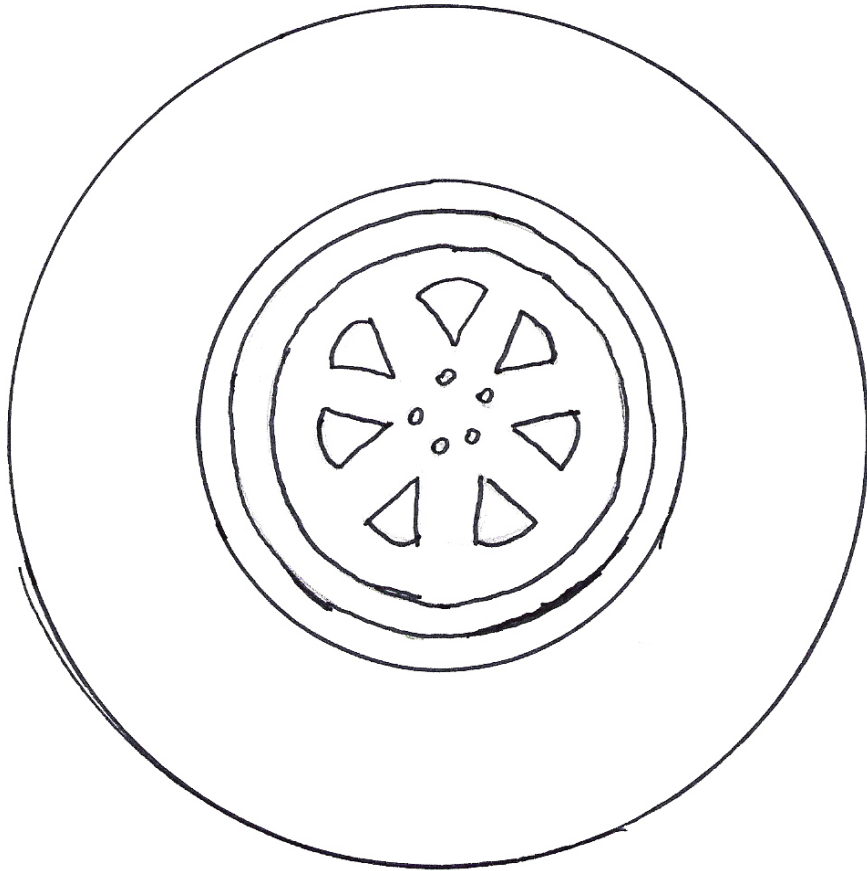

rueda

S

s

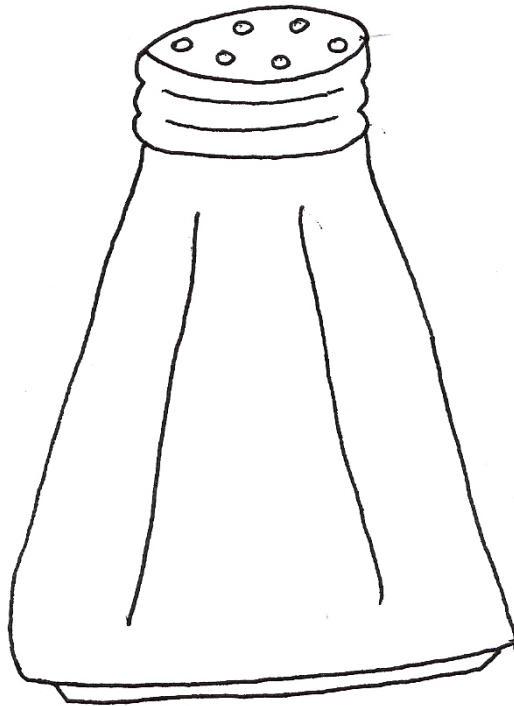

s alero

S

s

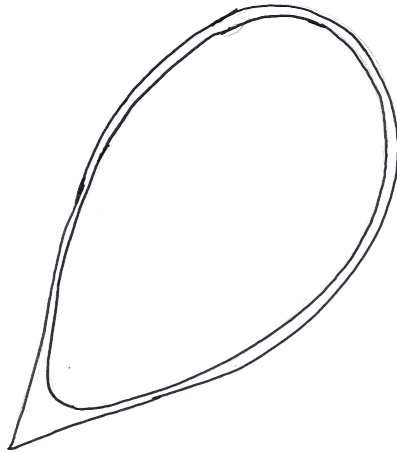
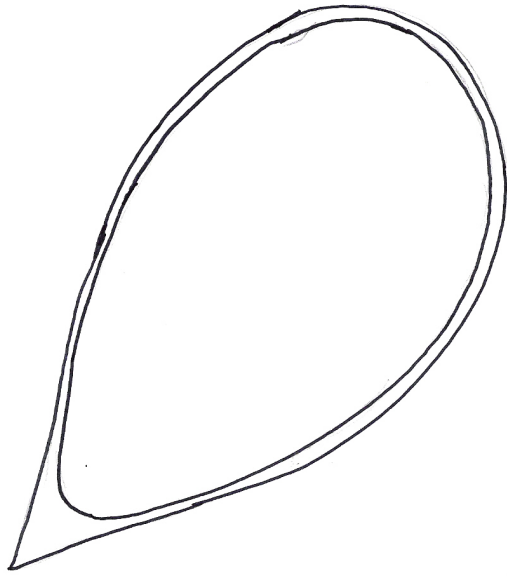

semillas

S

s

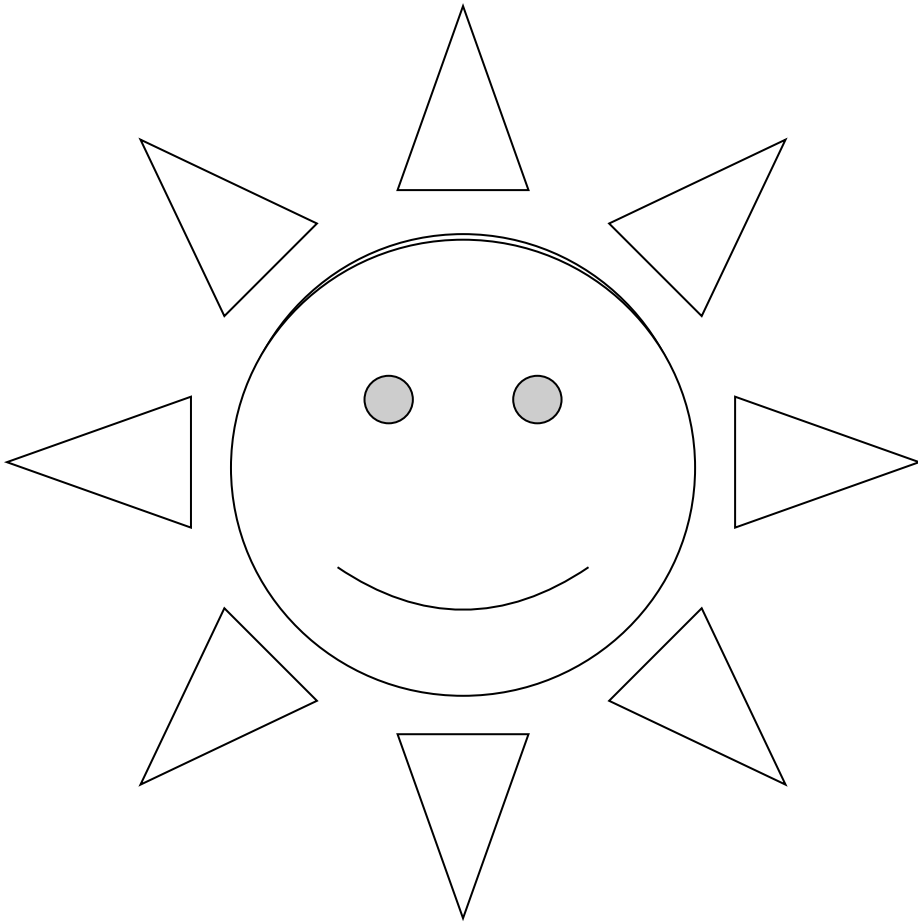

S

o

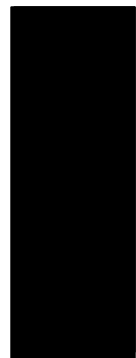

S

s

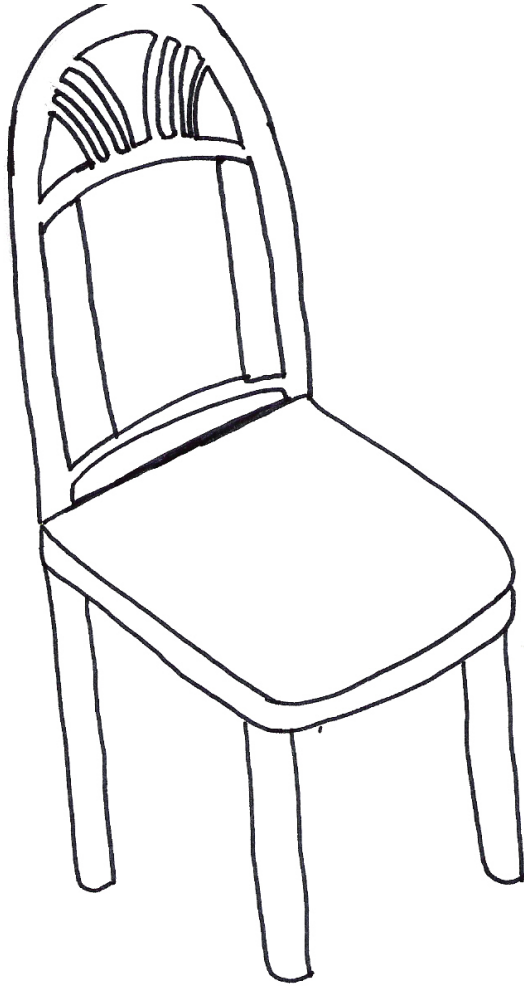

silla

S

S

+

2

3



5

Suma

T

t



t **a** **z** **a**

T

†



telefóno

T

t

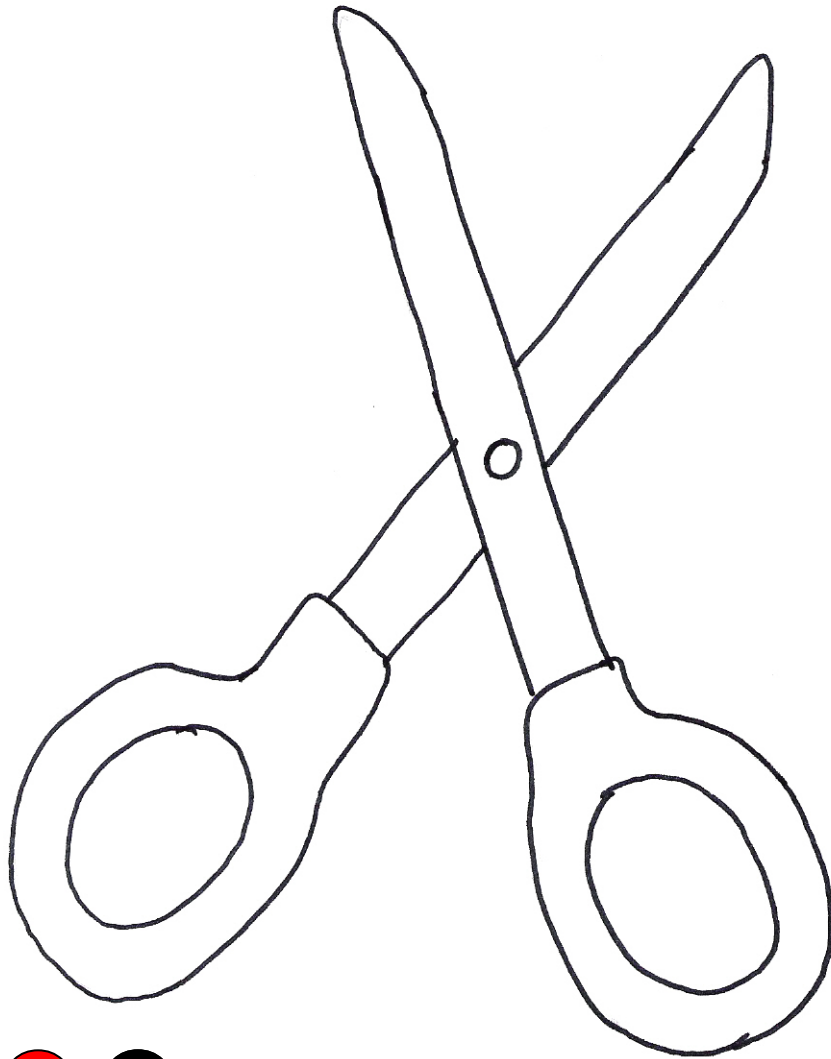

tijeras

T

t



tomate

T

t

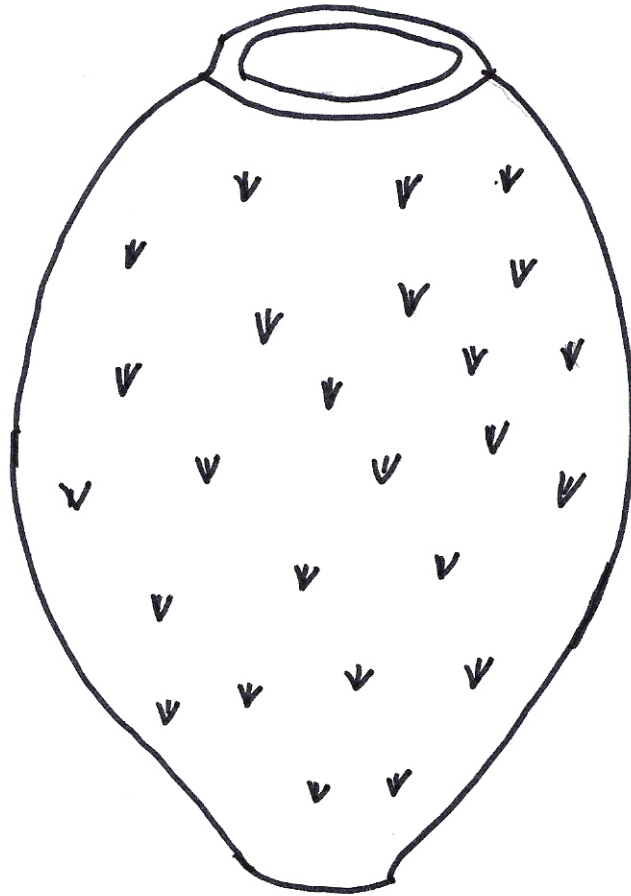

tuna

Tr

tr

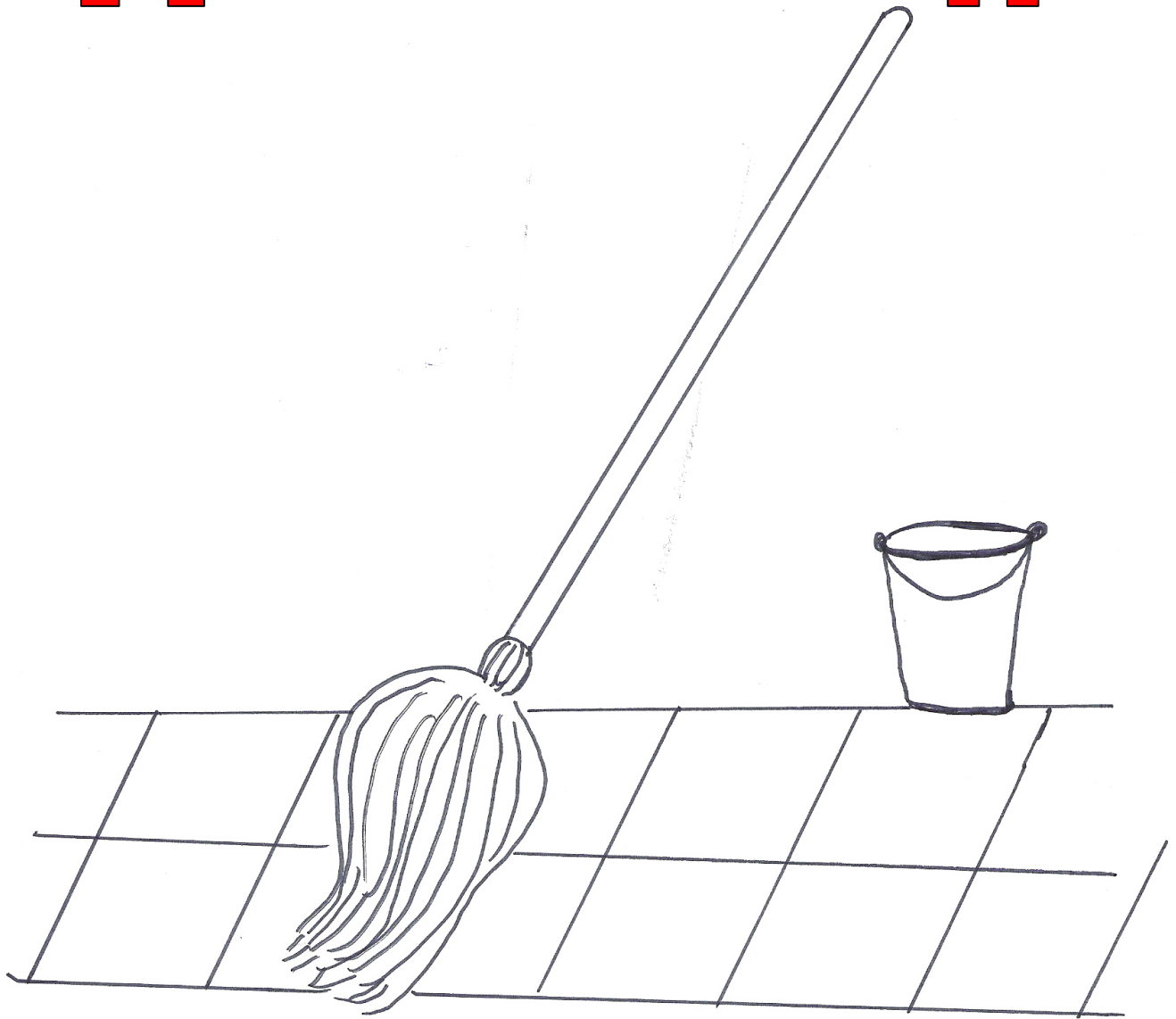

trapeador

Tr

tr

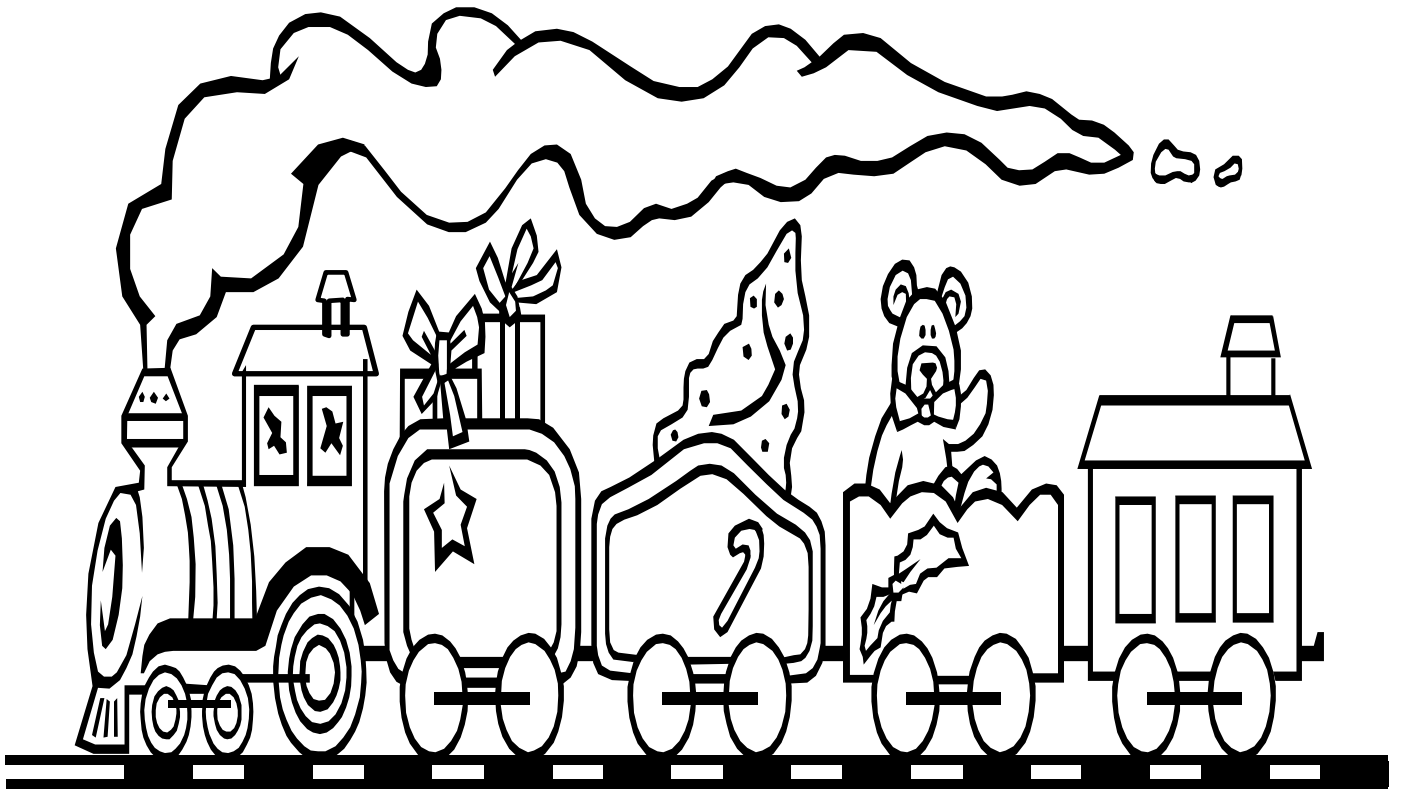

tr **e** **n**

Tr

tr

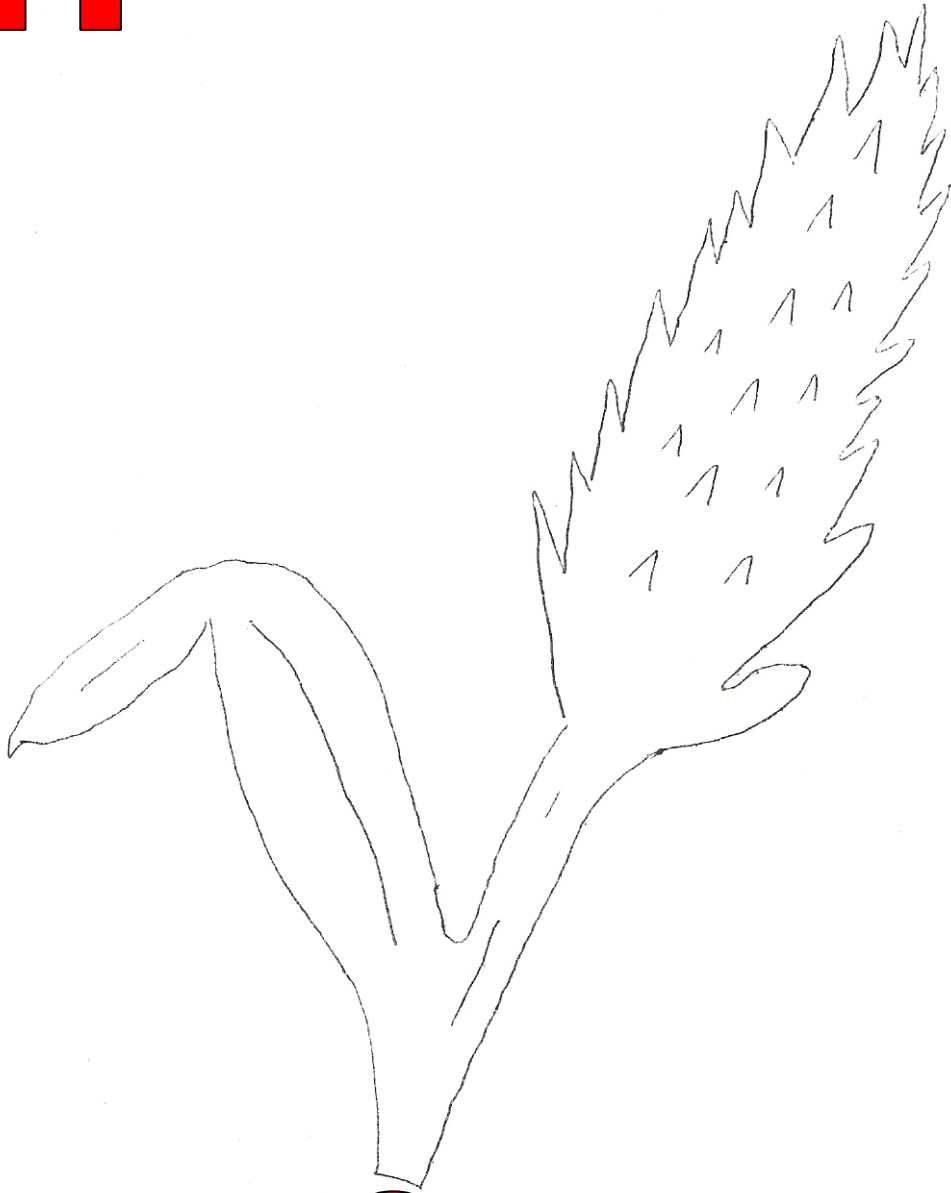

trigo

Tr

tr



trompo

U

U

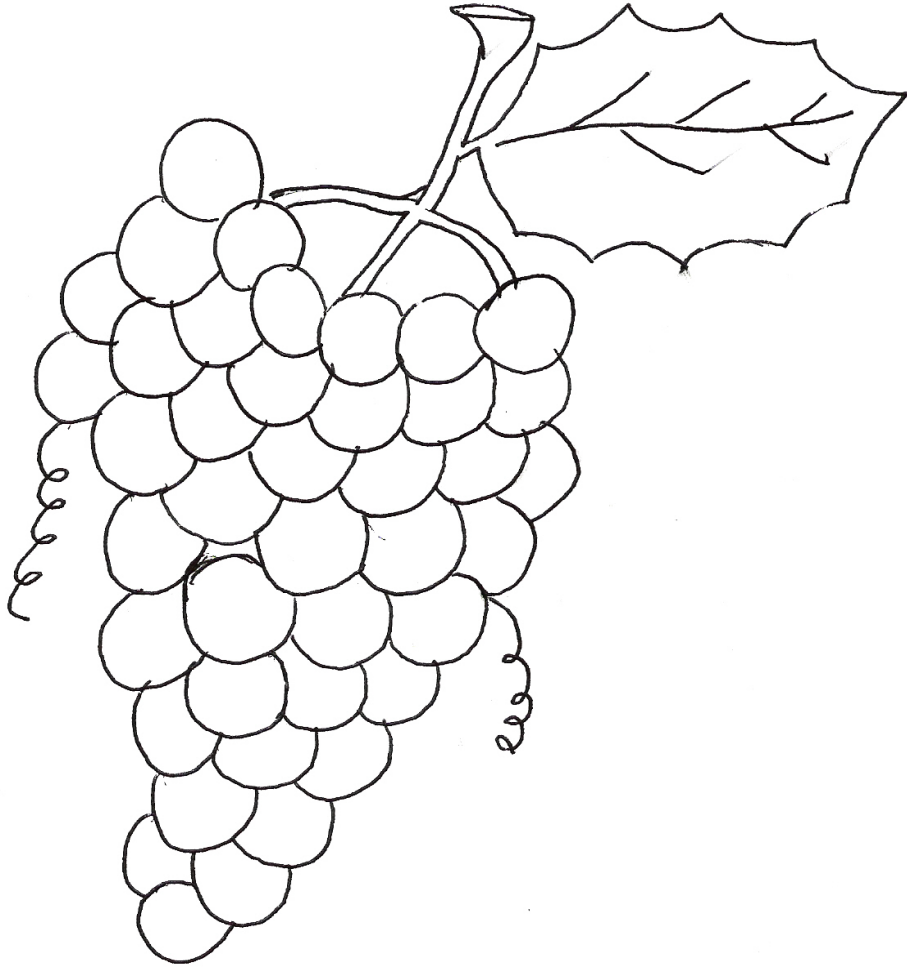

Uvas

V

v

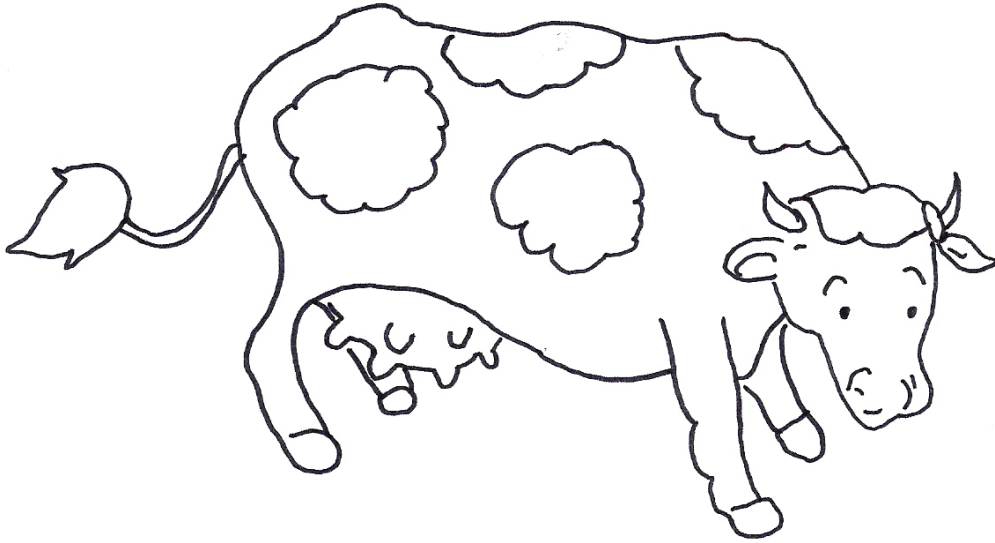

vaca

V

v

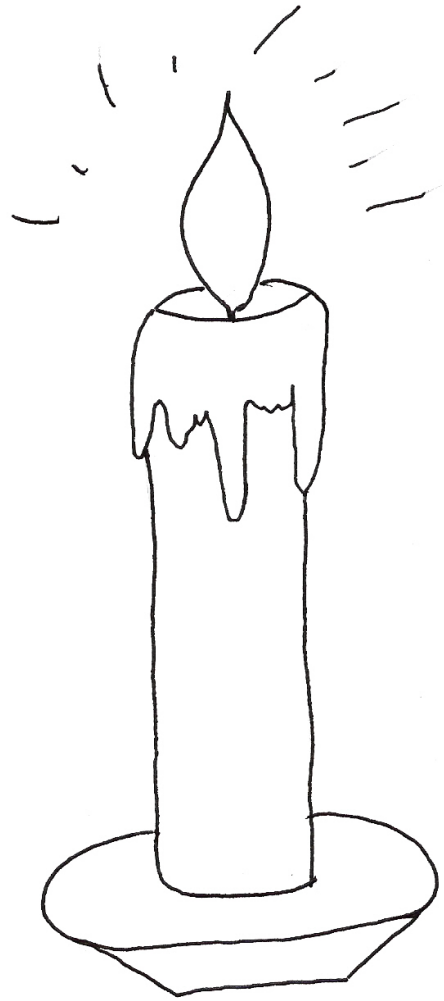

v vela

V

v

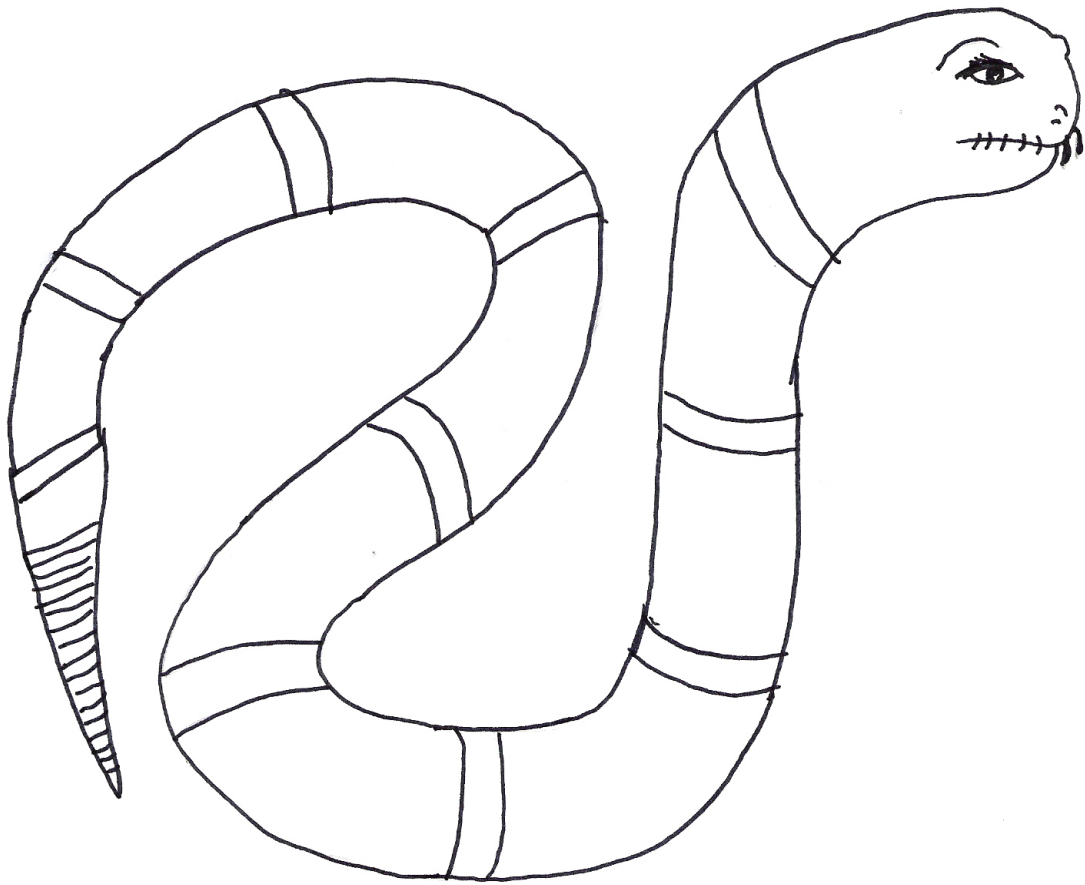

víborá

V

v

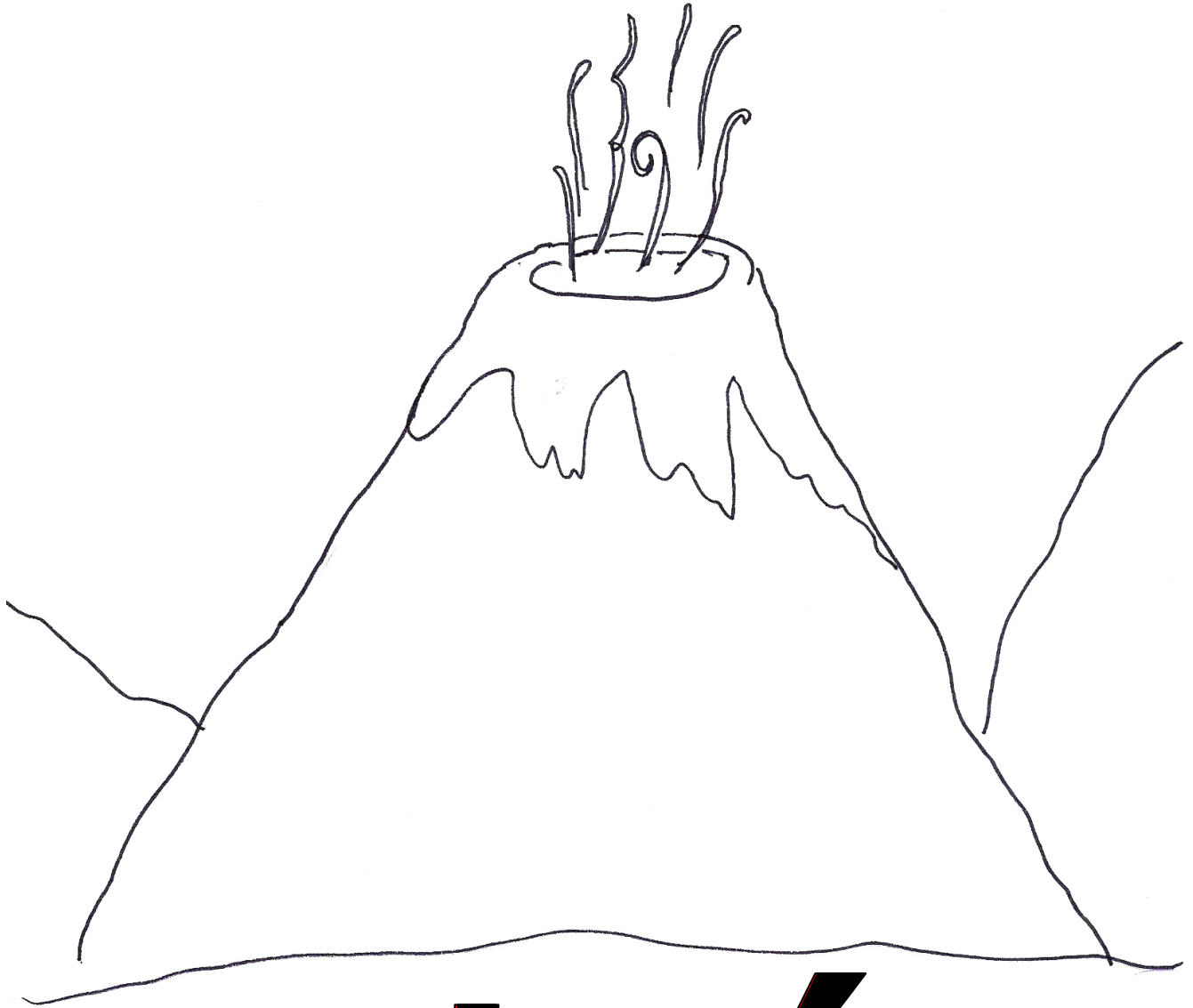

volcán

V

v

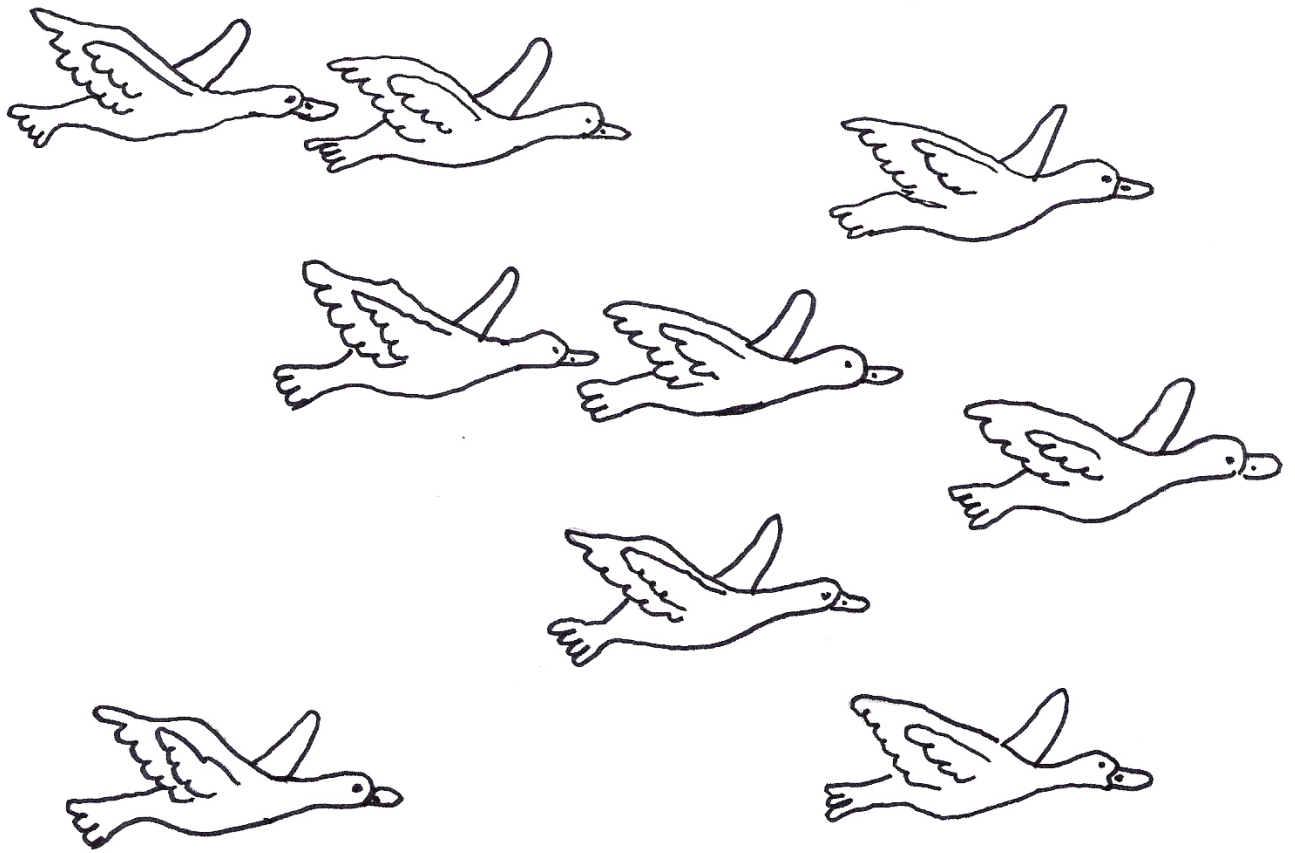

vuelan

W

w



winni

Y

y

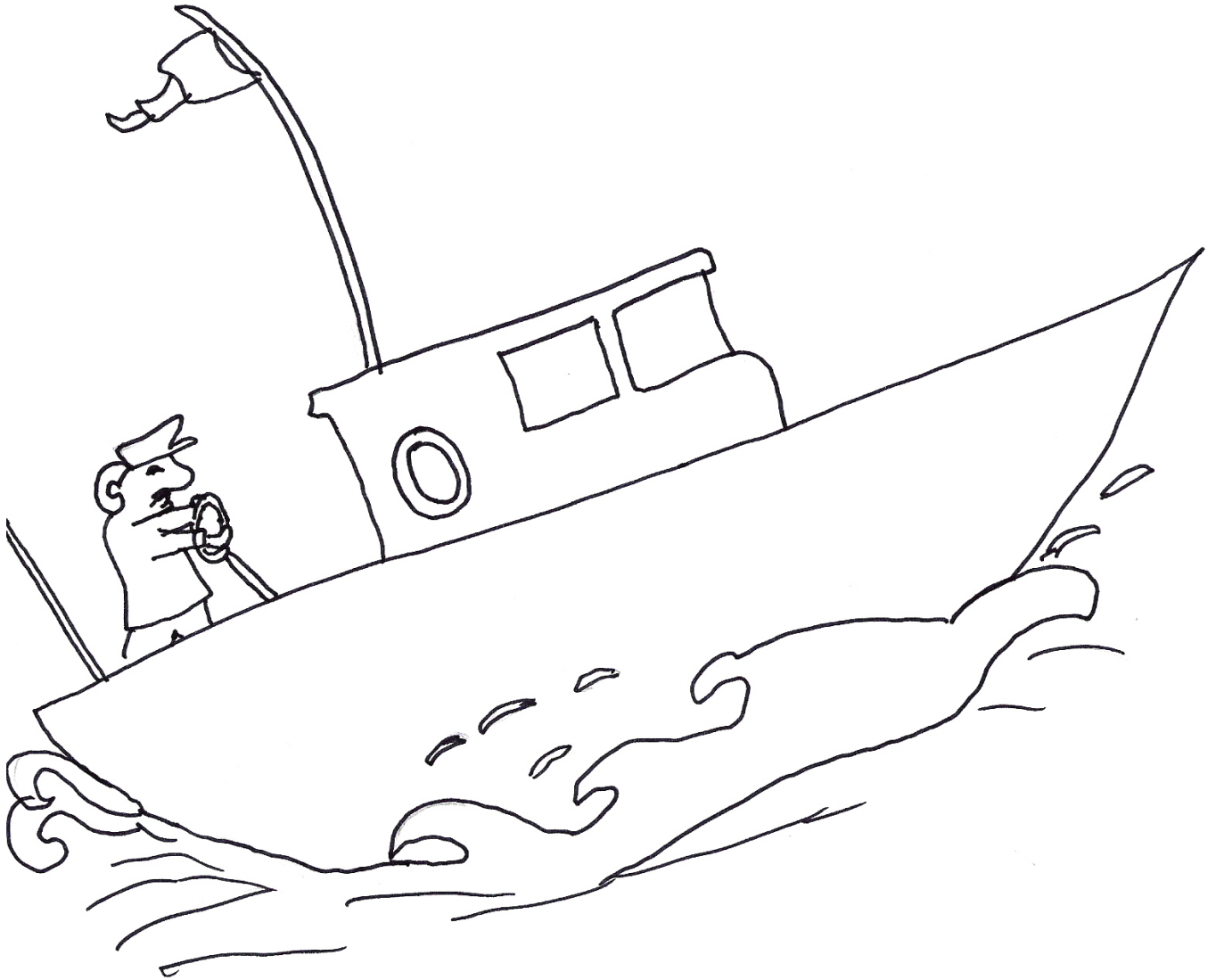

yate

Y

y

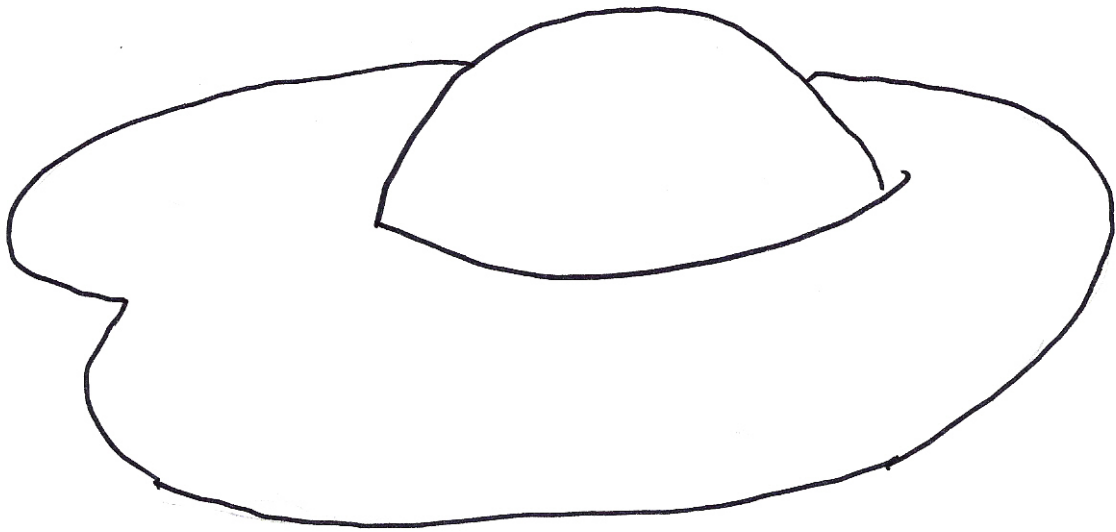

yema

Y

y

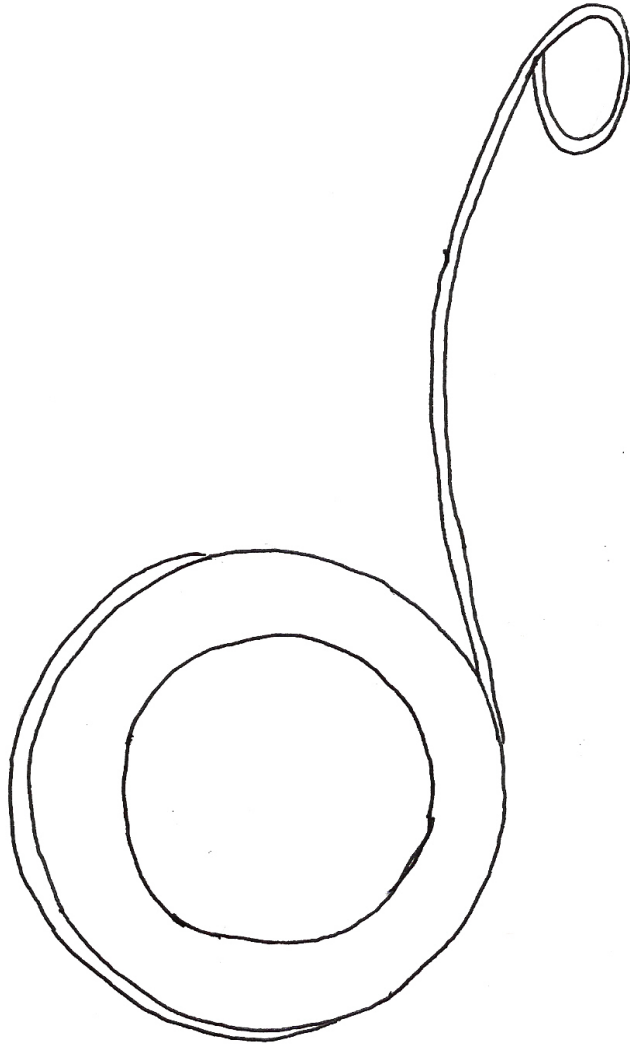

y o y o

Y

y



yucateca

Z

Z

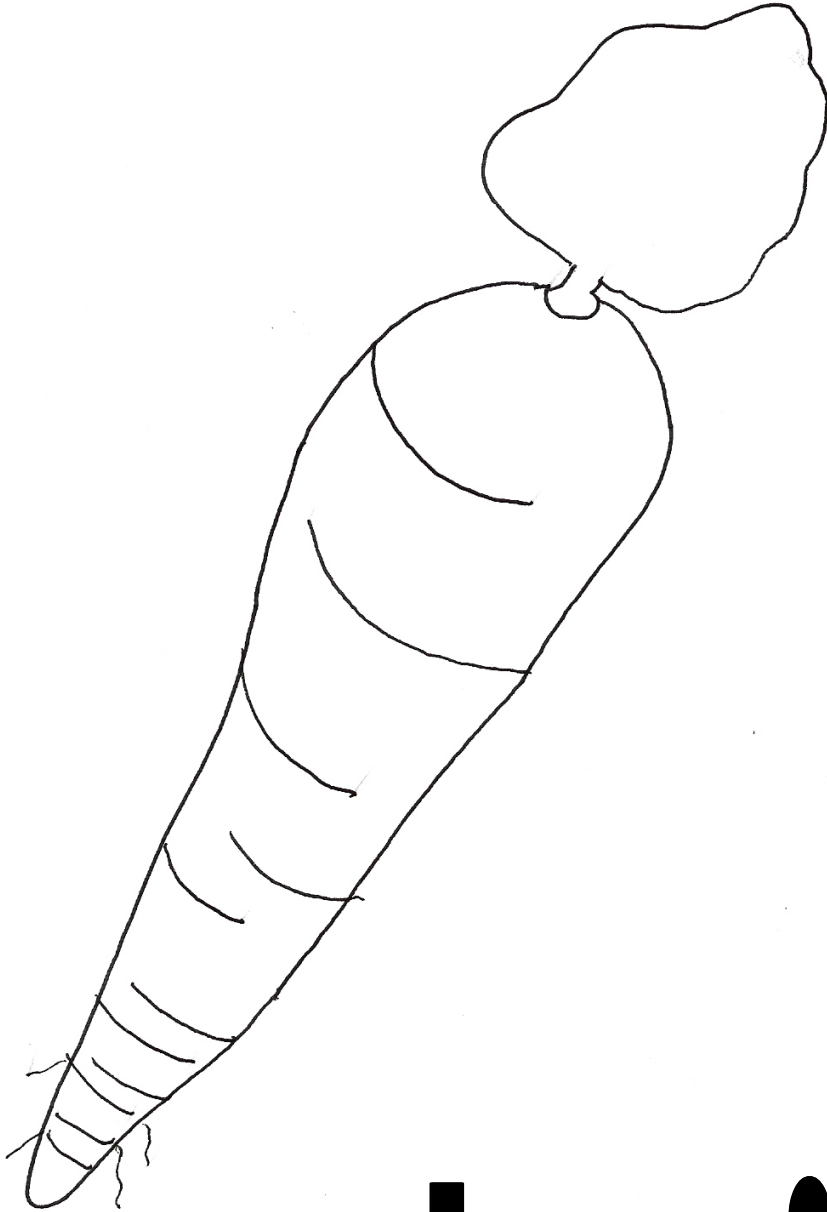

zanahoria

Z

z

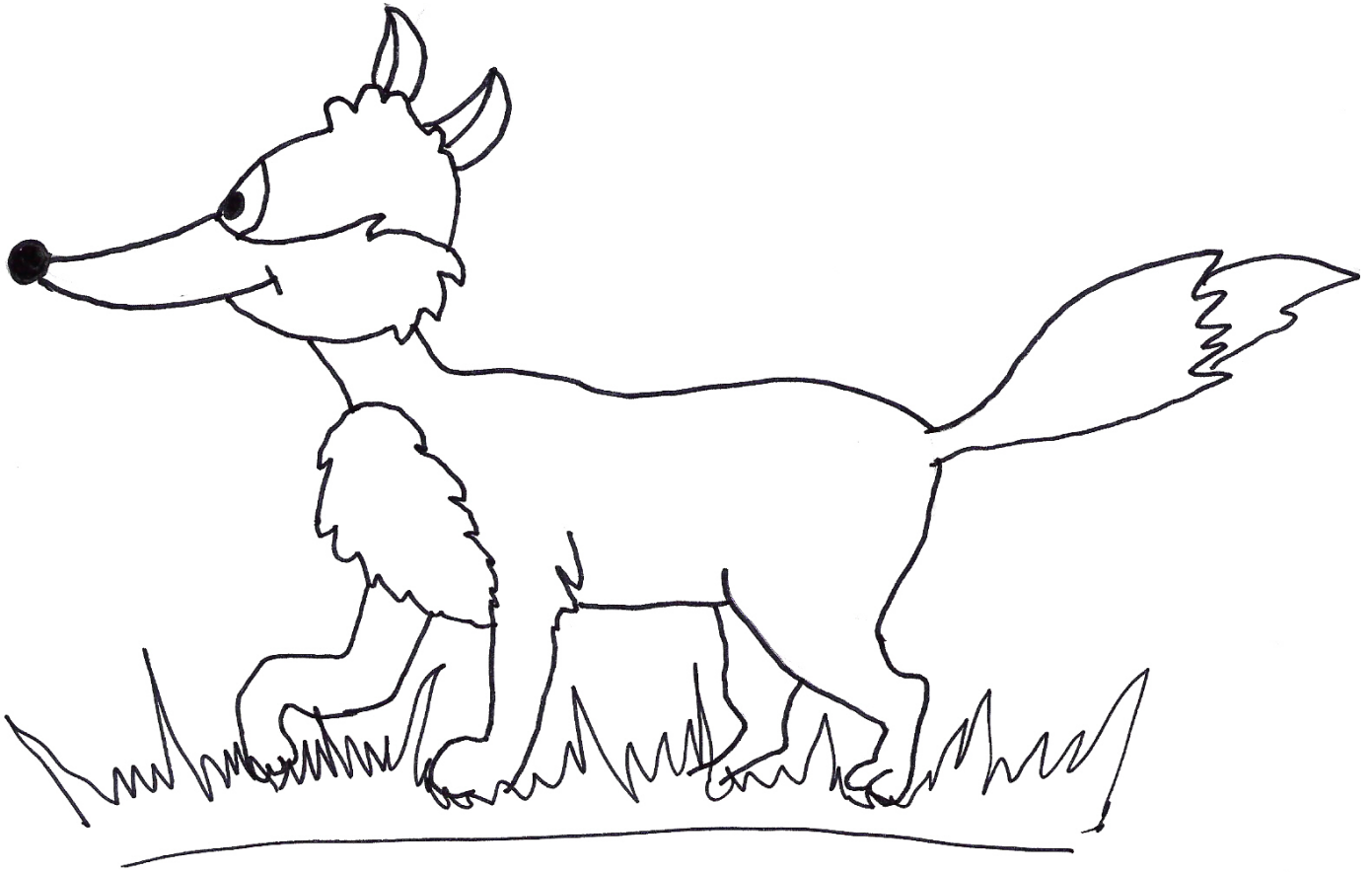

Zorro

Z

z

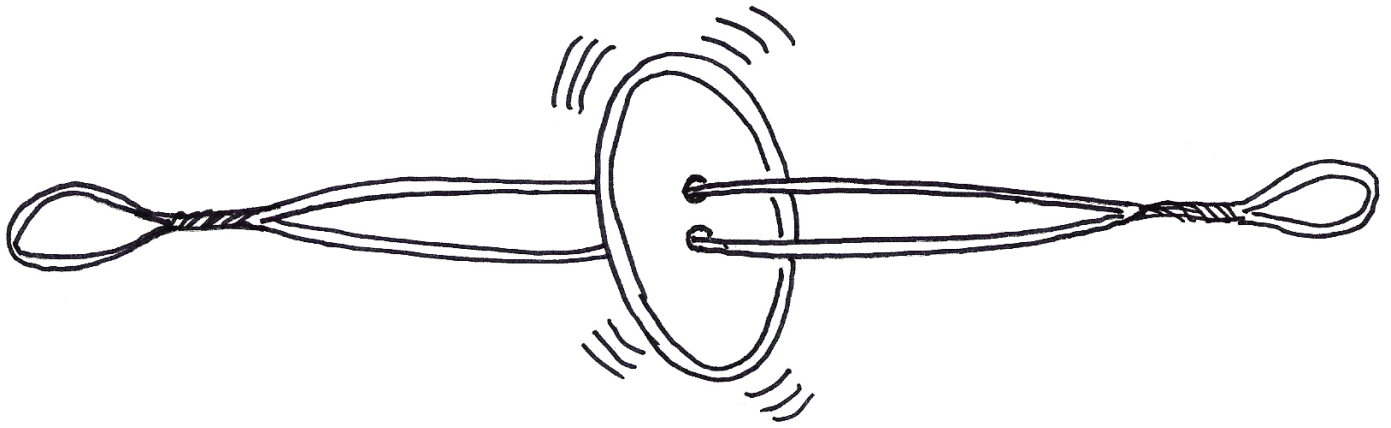

zumbador